

SPECIFICATIONS

WORKSHOP

# XL<sup>3</sup> S 4000

DISTRIBUTION ENCLOSURES



THE GLOBAL SPECIALIST IN ELECTRICAL  
AND DIGITAL BUILDING INFRASTRUCTURE



XL<sup>3</sup> S 4000 is a range optimized for collective housing and commercial buildings. Thanks to its ease of use and great flexibility, this offer is geared towards panel builders.

A wide selection was engineered for your needs: 2 heights, 3 depths available in four 4 widths corresponding to 16, 24, 36 modules and external cable sleeves.

The structure comes fully assembled and ready-to-use. The rear and side panels are supplied separately.

The installation of devices in the enclosure can be released using three different ways according to the panel builder's requirements.

Thanks to a wide variety of accessories, multiple mounting possibilities exist for all dimensions of enclosures.

XL<sup>3</sup> S 4000 main innovation is the front or back optimized access to the panel.

With the help of multiple busbar systems, XL<sup>3</sup> S 4000 was designed to facilitate wiring and connection installations and allows an easy access when it comes to maintenance.

#### LEGAL INFORMATION

Presentation pictures do not always include Personal Protective Equipment (PPE), but this is a legal and regulatory obligation that must be scrupulously respected.

In accordance with its continuous improvement policy, Legrand reserves the right to change the specifications and illustrations without notice. All illustrations, descriptions and technical information included in this document are provided as indications and cannot be held against Legrand.



# TABLE OF CONTENTS

Safety instructions .....	2
Product range presentation.....	4
Choice table .....	6
How to mount enclosures? .....	8
Dimensions .....	8
Removing plates to allow cable passage .....	9
Plinths .....	9
Finishing panels for plinths .....	9
Mounting of the back and side panels .....	10
Subpanel mounting .....	10
Seal for IP43 .....	11
Association and joining kits .....	11
IP30 Finishing kit .....	13
Angle enclosure .....	14
Mounting lateral functional upright .....	15
Mounting central upright .....	16
Doors mounting .....	18
Front panel support .....	21
Individual faceplate .....	22
Doors equipotential link, lateral panels and faceplates .....	22
Internal cable sleeves kit .....	24
Floor fixation (Dimensions table) .....	25
How to mount devices?.....	26
Principle of volumes definition .....	26
Equipment mounting table .....	27
Fixation options : plates, rail, adapter rails, busbars and plain plates .....	36
Mounting SPX/SPX-D/SPX <sup>3</sup> -V .....	43
Mounting DMX <sup>3</sup> .....	48
Cabling and junction .....	50
Wiring guide for aluminum rail .....	50
LINA 25 duct .....	50
Terminal blocks .....	52
Cable fixing .....	53
Cable passage between the door and the enclosure .....	54
Cable entry .....	55
Treating protective conductors .....	56
Distribution system .....	58
Busbars .....	66
Other accessories .....	90
Blanking plates .....	90
Document holders .....	91
Label holders .....	91
Enclosures shipping and handling .....	92
Via lifting truck, via lifting .....	92
Spare parts & accessories .....	93
Documentation .....	99

# SAFETY

# INSTRUCTIONS

## General information

- Use only the products and accessories recommended by the Legrand Group in the catalogue, instructions, technical data sheets and all other documents provided by Legrand (hereinafter referred to as «the Documentation») in compliance with the installation rules.
- Improper installation and/or use may result in the risk of arcing in the enclosure, overheating or fire. The enclosures must be used under normal conditions, they must not be subjected to Voltage / Current / Temperature values other than those specified in the Documentation.
- Legrand declines all responsibility for any modification or repair of the equipment making up the enclosure that is not authorized by the Legrand Group, as well as any failure to comply with the rules and recommendations specified by Legrand in the Documentation. In addition, in the cases mentioned above, the warranty granted by Legrand will not be applicable.
- It is necessary to check that the characteristics of the products are appropriate for their environment and use during maintenance operations, and to refer to the Documentation. If you have any questions or require clarification, please contact Legrand Group.
- The installation, use and maintenance of the enclosures and their components must be carried out by qualified, trained and authorized personnel, in accordance with the regulations in force in each country.



### **RISK OF ELECTRIC SHOCK, BURNS AND EXPLOSION.**

- People working on the installation must have the appropriate electrical authorizations for the work to be carried out.
- Wear the PPE (Personal Protective Equipment) necessary to work on live products.
- Respect the safety rules related to electrical work.
- Improper electrical and mechanical use of equipment can be dangerous and may result in personal injury or damage to property.
- Depending on the maintenance operations to be carried out, partial or total power cuts of the enclosure concerned should be planned before any work.
- When performing operations that involve access to the inside of the enclosure, be aware of the risk of burns before touching any products or metal parts.
- Before turning the power back on, make sure that there are no foreign bodies and that all physical protections have been put back in place (e.g.: screens, covers, shields).

Any failure to strictly apply the procedures and to respect these recommendations, could lead to serious risk of accident, endangering people and property (in particular, without limitation, risk of burns, electric shocks, etc.).



 The rules and recommendations in this document are based on our knowledge of the typical conditions of use of our products in the fields of application usually encountered. However, it is always the customer's responsibility to verify and validate that Legrand products are suitable for its installation and use.

The customer must ensure proper installation, maintenance and operation of the equipment to avoid any risk of injury to personnel or damage to property in the event of product failure, especially for applications that require a very high level of safety (e.g., those in which the failure of a component may endanger human life or health).

The rules for storage, handling, installation and maintenance and the appropriate precautions and warnings must be strictly observed and applied.

# XL<sup>3</sup> S 4000 RANGE

XL<sup>3</sup> S 4000 enclosures enable to achieve your projects suitable to different environments.

## CHARACTERISTICS

- Class I metallic cabinet
- Short-circuits resistance  
I<sub>pk</sub>: 105 kA, I<sub>cc</sub>: 50 kA
- IP 30 without door, IP 40 with door, IP 43 with a special seal
- IK 07 without door, IK 08 with door
- Door opening angle: 180°
- Conform to IEC 61439-2 standard
- Can accept devices up to 4000 A
- Colors: Body RAL 7016
- Faceplates and doors RAL 9003
- Rated insulation voltage (U<sub>i</sub>): 1000 V
- Temperature range : -5°C à +40°C
- Storage temperature : -10°C à +70°C
- Sheet thickness : 2 mm
- Panel and door thickness: 1.5 mm
- Maximum load : 500 Kg

## PRODUCT SELECTION

XL<sup>3</sup> S 4000 is composed of enclosures available in:

- 4 different widths:  
16, 24, 36 modules and cable sleeves
- 3 depths:  
400 mm, 600 mm and 800 mm
- 2 heights:  
1800 mm and 2000mm  
(usable: 1800mm and 2200mm)

 Possibility to choose a special colour from a panel of 197 shades: RAL only possible on metal parts.

For any request about technical possibilities and extra costs, please contact the technical support:  
[support-technique-edia.fr-lgs@legrand.fr](mailto:support-technique-edia.fr-lgs@legrand.fr)





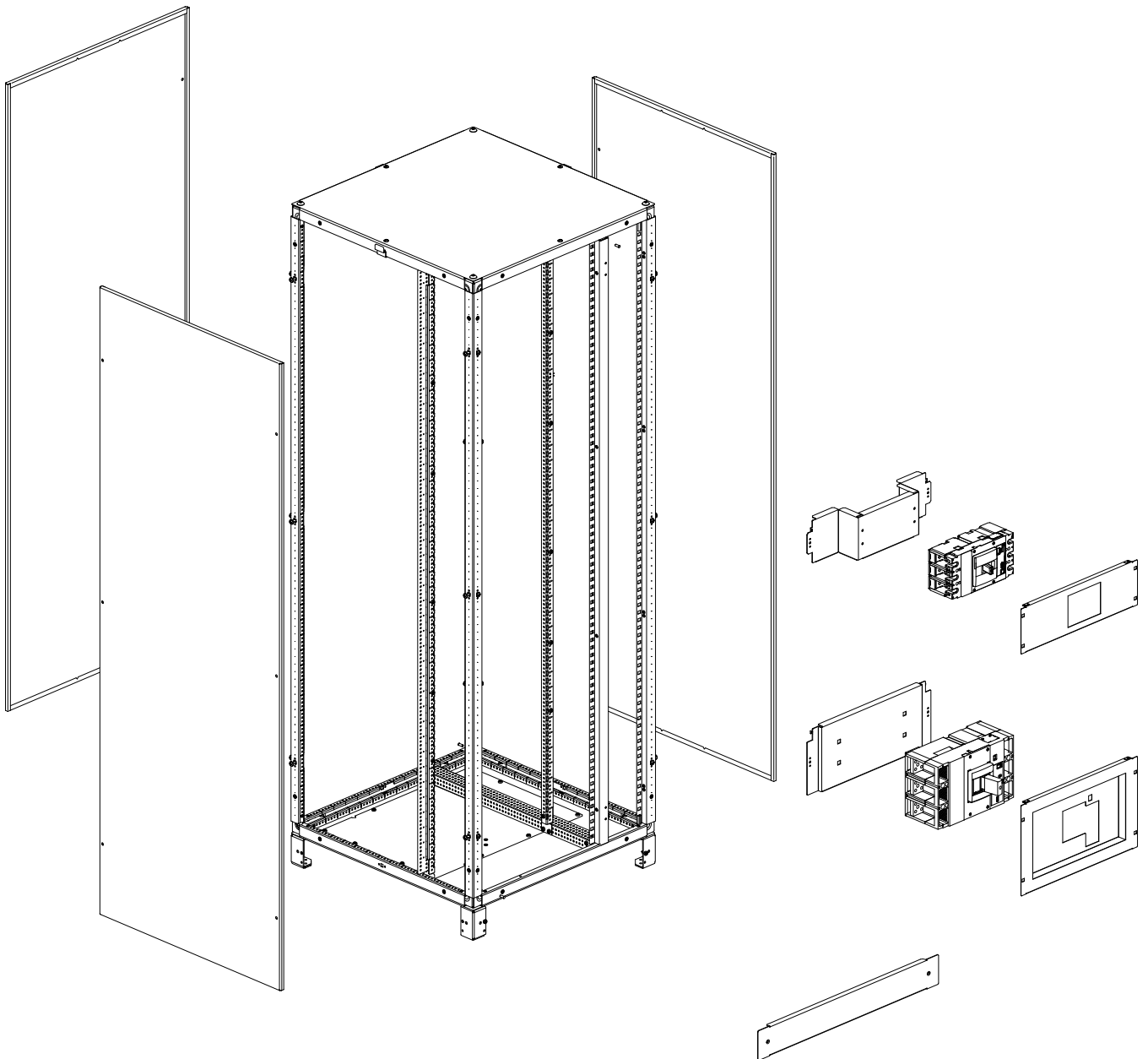

# XL<sup>3</sup> S 4000 ENCLOSURES

## XL<sup>3</sup> S 4000 ENCLOSURE RANGE

Width	16 MODULES					
	Depth 400 mm		Depth 600 mm		Depth 800 mm	
Height (mm)	H 2000	H 2200	H 2000	H 2200	H 2000	H 2200
Enclosure	3 380 01	3 380 21	3 380 05	3 380 25	3 380 09	3 380 29
metallic door	3 381 01	3 381 11	3 381 01	3 381 11	3 381 01	3 381 11
Glass door	3 381 20	3 381 30	3 381 20	3 381 30	3 381 20	3 381 30
Side panels	3 380 61	3 380 71	3 380 62	3 380 72	3 380 63	3 380 73
Rear panels	3 380 81	3 380 91	3 380 81	3 380 91	3 380 81	3 380 91
Finishing kit	3 379 72 + 3 379 67	3 379 72 + 3 381 80	3 379 72 + 3 379 67	3 379 72 + 3 381 80	3 379 72 + 3 379 67	3 379 72 + 3 381 80

Width	24 MODULES					
	Depth 400 mm		Depth 600 mm		Depth 800 mm	
Height (mm)	H 2000	H 2200	H 2000	H 2200	H 2000	H 2200
Enclosure	3 380 02	3 380 22	3 380 06	3 380 26	3 380 10	3 380 30
Metallic door	3 381 02	3 381 12	3 381 02	3 381 12	3 381 02	3 381 12
Glass door	3 381 21	3 381 31	3 381 21	3 381 31	3 381 21	3 381 31
Side panels	3 380 61	3 380 71	3 380 62	3 380 72	3 380 63	3 380 73
Rear panels	3 380 62	3 380 72	3 380 62	3 380 72	3 380 62	3 380 72
Finishing kit	3 379 73 + 3 379 67	3 379 73 + 3 381 80	3 379 73 + 3 379 67	3 379 73 + 3 381 80	3 379 73 + 3 379 67	3 379 73 + 3 381 80

Width	36 MODULES					
	Depth 400 mm		Depth 600 mm		Depth 800 mm	
Height (mm)	H 2000	H 2200	H 2000	H 2200	H 2000	H 2200
Enclosure	3 380 03	3 380 23	3 380 07	3 380 27	3 380 11	3 380 31
Metallic door	3 381 03	3 381 13	3 381 03	3 381 13	3 381 03	3 381 13
Glass door	3 381 22	3 381 32	3 381 22	3 381 32	3 381 22	3 381 32
Side panels	3 380 71	3 380 61	3 380 62	3 380 72	3 380 63	3 380 73
Rear panels	3 380 63	3 380 73	3 380 63	3 380 73	3 380 63	3 380 73
Finishing kit	3 379 74 + 3 379 67	3 379 74 + 3 381 80	3 379 74 + 3 379 67	3 379 74 + 3 381 80	3 379 74 + 3 379 67	3 379 74 + 3 381 80

Width	EXTERNAL CABLE SLEEVE					
	Depth 400 mm		Depth 600 mm		Depth 800 mm	
Height (mm)	H 2000	H 2200	H 2000	H 2200	H 2000	H 2200
Enclosure	3 380 00	3 380 20	3 380 04	3 380 24	3 380 08	3 380 28
Metallic door	3 381 00	3 381 10	3 381 00	3 381 10	3 381 00	3 381 10
Side panels	3 380 61	3 380 71	3 380 62	3 380 72	3 380 63	3 380 73
Rear panels	3 380 80	3 380 90	3 380 80	3 380 90	3 380 80	3 380 90
Finishing kit	3 379 71 + 3 379 67	3 379 71 + 3 381 80	3 379 71 + 3 379 67	3 379 71 + 3 381 80	3 379 71 + 3 379 67	3 379 71+ 3 381 80
Faceplate	3 378 96	3 381 50	3 378 96	3 381 50	3 378 96	3 381 50

# ENCLOSURES MOUNTING

The enclosures are supplied fully assembled with the 4 structure's uprights, the "roof-base", a movable plate to allow cable entry, and 4 corner pieces for plinth.

## 1 DIMENSIONS

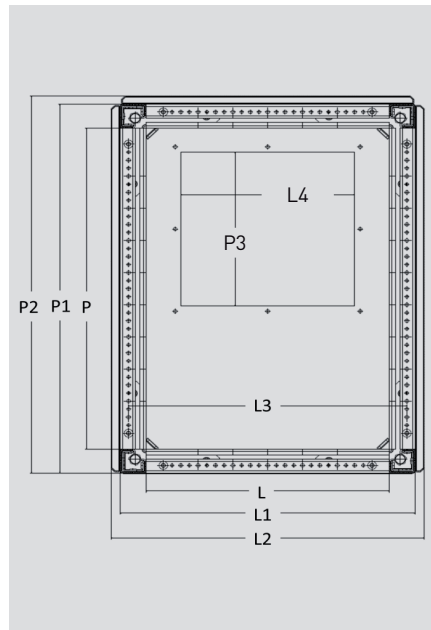
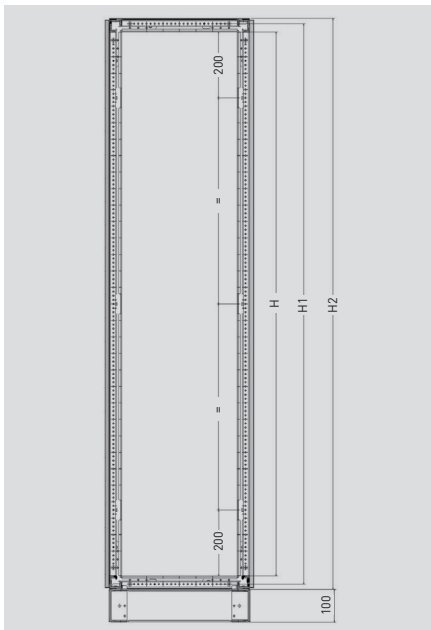

The front part of the enclosure is identifiable because of the absence of holes on the base rail:

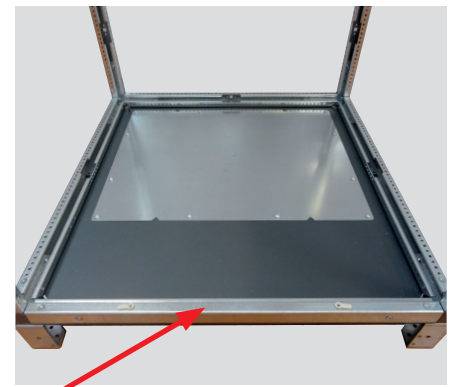

Index: holes absent = front part of the enclosure

Cat.No	H (mm)	H1 (mm)	H2 (mm)			
3 380 00	1800	1850	1881			
3 380 01						
3 380 02						
3 380 03						
3 380 04						
3 380 05						
3 380 06						
3 380 07						
3 380 08						
3 380 08						
3 380 09						
3 380 10						
3 380 11						
3 380 20				2000	2050	2081
3 380 21						
3 380 22						
3 380 23						
3 380 24						
3 380 25						
3 380 26						
3 380 27						
3 380 28						
3 380 29						
3 380 30						
3 380 31						

Cat.No	W (mm)	W1 (mm)	W2 (mm)	W3 (mm)	W4 (mm)
3 380 00	250	324	350	300	150
3 380 20					
3 380 04					
3 380 24					
3 380 08	350	424	450	400	250
3 380 28					
3 380 01					
3 380 21					
3 380 05	500	574	600	550	400
3 380 25					
3 380 09					
3 380 29					
3 380 02	700	774	800	750	600
3 380 22					
3 380 06					
3 380 26					
3 380 10	700	774	800	750	600
3 380 30					
3 380 03					
3 380 23					
3 380 07	700	774	800	750	600
3 380 27					
3 380 11					
3 380 31					

Cat.No	D (mm)	D1 (mm)	D2 (mm)	D3 (mm)
3 380 00	300	374	387	90
3 380 20				
3 380 04				
3 380 24				
3 380 08	700	774	787	440
3 380 28				
3 380 01				
3 380 21				
3 380 05	500	574	587	240
3 380 25				
3 380 09				
3 380 29				
3 380 02	300	374	387	90
3 380 22				
3 380 06				
3 380 26				
3 380 10	700	774	787	440
3 380 30				
3 380 03				
3 380 23				
3 380 07	500	574	587	240
3 380 27				
3 380 11				
3 380 31				



## 2 REMOVING PLATES TO ALLOW CABLE PASSAGE

Remove the fixing screws using a Torx key S30. Make the holes where needed as there is no pre-cut. Then fix the plate: tightening torque -N.m.

Holes dimensions: see table and illustration on the previous page 8.

Picture of a plate inside a 36 modules enclosure, depth 800 mm

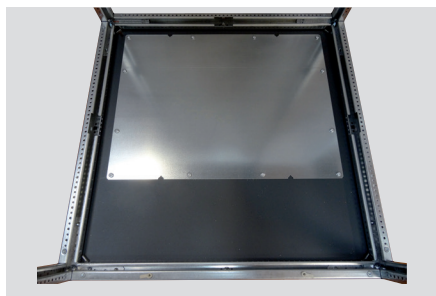

## 3 PLINTH CAT.NO 3 382 00

4 angles are already installed when you receive the enclosure.



To facilitate the passage of the inlet cables, you can only superpose 2 angle pieces.

Composition: 4 angle pieces, 4 M12 screws, 4 washers and 4 nuts. The ground bases fixing screws are not provided.

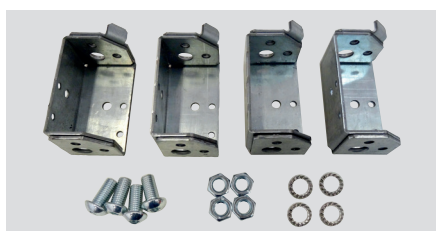

When superposing 2 bases, you need to join them. To succeed, you can lift the enclosure using a hoist or lanyards. If the enclosure is empty, you can lay down the enclosure in order to work efficiently and safely.

When achieved, insert the given screws (8 mm) through the 2 bases, then the washer and the nut. To finish, tighten using a flat-key (19 mm) and a key (8 mm), tightening torque 15 N.m.



Repeat the process for the other 3 angle pieces.

## 4 FINISHING PANELS FOR PLINTHS

### ■ Composition

The catalogue number is corresponding to 2 plates and 4 fixing screws.



### ■ 5 different lengths are available :

Cat.No	Length
3 382 01	350 mm
3 382 06	400 mm
3 382 02	450 mm
3 382 03	600 mm
3 382 04	800 mm

### ■ Mounting :

- Position the adapted covering between 2 angle pieces;
- Fix the 2 retainer screws, end-piece Torx S30, tightening torque 5 N.m.

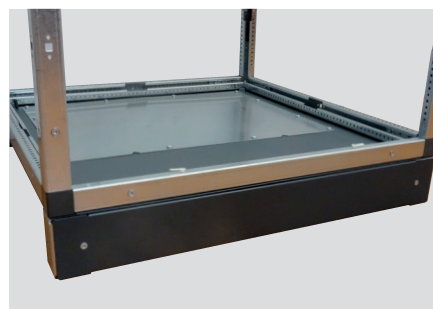

# XL<sup>3</sup> S 4000 ENCLOSURES

## 5 MOUNTING OF THE REAR AND SIDE PANELS (SEE THE CHOICE TABLE )

**!** For all mountings inside the enclosure, make sure to always use the largest holes (Ø 5.4 mm) to fix the equipment. Smaller holes (Ø 4.6 mm) are used to insert anti-rotation studs.

The catalogue number includes 1 panel and the accessories: 6 screws, 6 cage-nuts, 6 plastic washers, 1 retainer lug, and 1 self-tapping screw.



Position the retainer lug on the lateral crosspiece – upper part of the enclosure (middle of it) using the given screw - end-piece Torx S30, tightening torque 8 N.m.



Position the cage-nuts in the holes of the enclosures where needed, then ¼ turn to place them properly.



Position the screws and plastic washers in the holes of the lateral panels.



Fix the panel on the retainer lug and then secure it using the screws: Pozidriv n°3, tightening torque 1 N.m.

## 6 SUBPANEL MOUNTING

The use of a subpanel is necessary when pairing 2 envelopes of different depth.

The kit is available in 2 heights and is only suitable for an envelope depth difference of 200 mm.

**!** Cannot be installed between a 400 mm depth enclosure and an 800 mm.

- Install the 2 lugs (high and low) at a distance of 165 mm from the bottom of the deepest enclosure (1 screw/lug → Torx end cap T30, tightening torque 5 N.m.)



- Fix the upright using the 4 countersunk screws (2 screws/lug → Torx bit T30, tightening torque 5 N.m.) then join the 2nd enclosure..



- Insert the cage nuts into the subpanel support (x3).



- Secure this bracket with the 5 flat head screws (Torx T30 bit, tightening torque 5 N.m.). Example top screw:



- First attach the rear panel of the juxtaposed cell and then the subpanel after inserting the retaining bracket.



 The installation of the IP30 frame or door makes it impossible to mount this partial panel at the front of the enclosures.

### 7 IP43 SEALS (CAT.NO 3 379 51)

It is possible to get the IP43 by sticking the seal on the inner periphery of the side panels, plate for cable entry, 2 "roof-base" plates, door and between the enclosures if joined together. The seal self-adhesive.

Thickness	Width	Length
2 mm	10 mm	10 m

Installation of the door seal:  
- Hinges on the structure side



- Closing points on the structure side

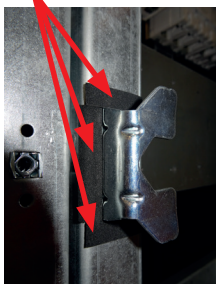

- Inner corner of the door (double the seal at the top and bottom)



- Passing through door openings



### 8 ASSOCIATION AND JOINING KITS (CAT.NO 3 379 49 AND 3 379 50)

2 joining kits exist :

- One required for joining up to 300 kg → Cat.No. 3 379 50
- One complementary up to 500 kg → Cat.No 3 379 49.

In this case, when joining you need to double the number of kits.

#### ■ Cat.No 3 379 50 :

8 screws, 2 nuts and 6 cage-nuts





# XL<sup>3</sup> S 4000 ENCLOSURES

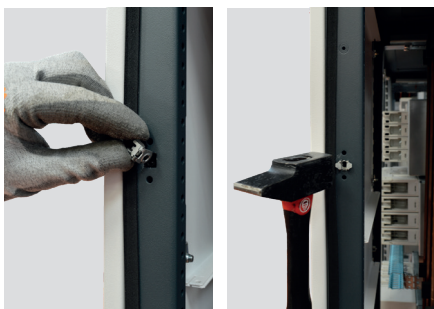

Join the two enclosures verifying for the absence of plinth panels on the enclosure's side.

Position the given screws in the back and front holes of the enclosure non-equipped with cage-nuts and tighten → hexagonal head 10 mm, tightening torque 8 N.m.

Example of a hole at the back of the screws passage:



Remove the 2 bases panels before joining the two enclosures (if present).

Position the 2 screws (or maximum 4 screws when superposing 4 bases) and 2 (or 4) nuts in the middle of the base(s) → Key 10 mm, tightening torque 8 N.m. .

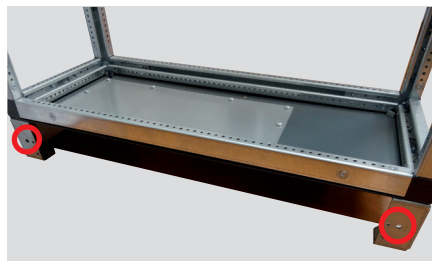

■ **Cat.NO 3 379 49 :**  
16 self-tapping screws, 3 flat plates and 1 link plate.

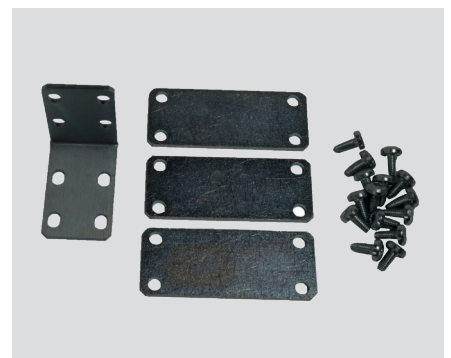

**!** When mounting inside the enclosure, make sure to always use the largest holes (Ø 5.4 mm) to fix the equipment. The smallest holes (Ø 4.6 mm) are used to insert anti-rotation studs.

Note that if the load is up to 500 kg, 2 kits are needed.

### How to install linkplates ? :

- Upper angle at the front face of your enclosure and lower angle at the back of your enclosure → **main power position at the top.**
- Upper angle at the back of the enclosure and lower angle at the front of the enclosure → **main power position at the bottom.**

Example of a link plate :

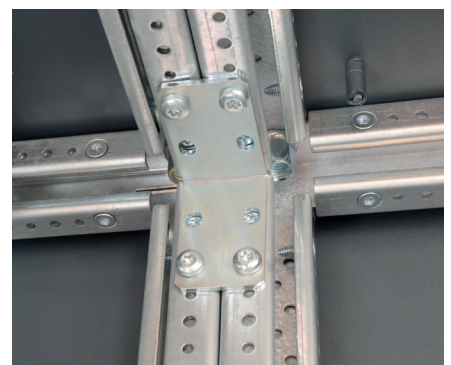



### How to install flat plates ? :

- On the rear structure uprights → x2 spread over the height
- Behind the front structure uprights → x2 spread over the height
- On the upper structure crosspieces → x1 half depth
- On the lower structure crosspieces → x1 half depth.

Example of two flat plates :



Use a Torx S30 end-piece, tightening torque 8 N.m. to fix the screws.

### 9 IP30 FINISH KIT (2 CATALOGUE NUMBERS TO ORDER → SEE CHOICE TABLE)

#### ■ 1<sup>st</sup> catalogue number :

Finish kit for vertical mounting

#### ■ Composition :

2 metal strips + screws + cage-nuts

#### ■ 2<sup>nd</sup> catalogue number :

Finish kit for horizontal mounting

#### ■ Composition :

2 metal strips + 4 screws + 4 plastic plugs

Position the cage-nuts in the enclosure's front structure uprights holes :



Join a vertical strip with a horizontal strip and make sure to insert correctly the ergot in the slot :

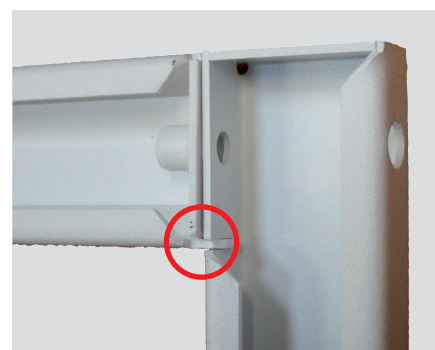
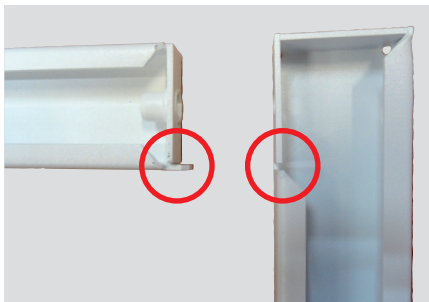

Position the given screw with the horizontal strip and tighten → Pozidriv n°3, tightening torque 8 N.m.



# XL<sup>3</sup> S 4000 ENCLOSURES

In order to ensure the IP, clog the vertical strip's hole using the plastic plug provided:



Repeat the process for the other 3 angles. When the frame is assembled, fix it onto the enclosure using the screws provided with the vertical strips → Pozidriv n°3, tightening torque 5 N.m. Make sure to position the logo in the right way :



## 10 ANGLE ENCLOSURE

The enclosure is delivered assembled with the door, the 2 rear panels, the 5 mounted plinths, the 2 covers for the rear plinths and the cover for the front plinth.



### ■ Joining of a single envelope

It is necessary to order 2 kits Cat.no 3 379 49 and 1 kit Cat.no 3 379 50 (see pages 11 and 12).

### ■ Pairing of 2 envelopes (1 on each side)

It is necessary to order 4 kits Cat.no 3 379 49 and 2 kits Cat.no 3 379 50 (see pages 11 and 12).

In case of superimposition (2 angles maximum), 3 kits are available. They each consist of a front plinth cover, 2 rear plinth covers, 5 plinths and screws and bolts.

Depth (mm)		
400	600	800
3 382 10	3 382 11	3 382 12

If the enclosure is the last part of the TGBT, it is necessary to order 1 cover for base (or 2 in case of superimposition) → see Cat.no page 9, as well as a side panel → see Cat.no page 6 and 7.

## 11 MOUNTING LATERAL FUNCTIONAL UPRIGHTS

2 catalogue numbers are available :

Cat.No	Height
3 381 55	2000 mm
3 381 57	2200 mm

### ■ Composition

2 uprights, 4 fixing lugs, 12 self-tapping screws. Equipment can be mounted in a vertical or horizontal position.

Picture: upper uprights positioned properly :

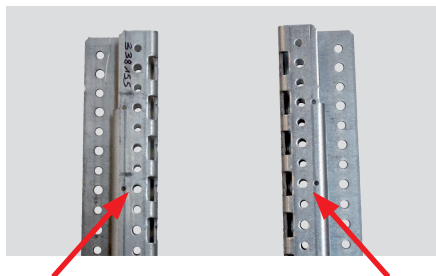

Left upright

Right upright

Position the lugs properly (upper and lower) then fix them on the uprights using the self-tapping screws provided (1 screw per lug) → Torx S30 end-piece, tightening torque 5 N.m.

Left upright (upper)

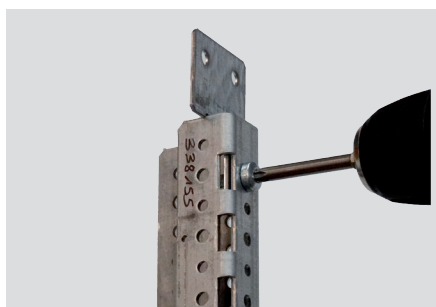

Right upright (upper)



Fix the 2 parts “upright-lug” on the enclosure’s structure: 2 screws per lug. The first screw is placed at 175 mm from the inner structure’s upright at the front of the enclosure: Torx S30 end-piece, tightening torque 5 N.m.

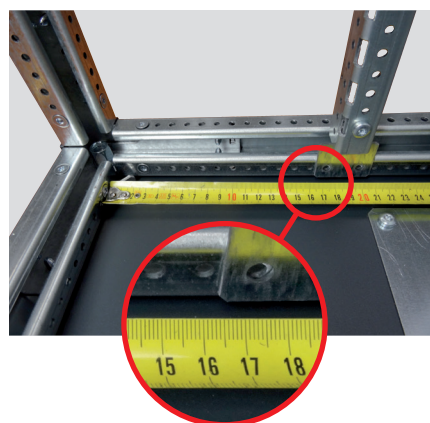

- You can also keep a free space at the top or at the bottom of the enclosure to:
- Facilitate the installation of the main power
  - Put in place a DMX<sup>3</sup>

# XL<sup>3</sup> S 4000 ENCLOSURES

To succeed, you need to get a set of crosspieces, catalogue number 3 397 34 (depth 400 mm) or 3 397 35 (depth 600 mm) or 3 397 36 (depth 800 mm).

To keep a 200 mm free space, position the fixing screws of your 2 crosspiece's lugs at 225 mm from the structure (Torx S30 end-piece, tightening torque 5 N.m.)

Insert the crosspiece in the 2 lugs, then fix it using 2 S30 Torx screws → tightening torque 5 N.m.

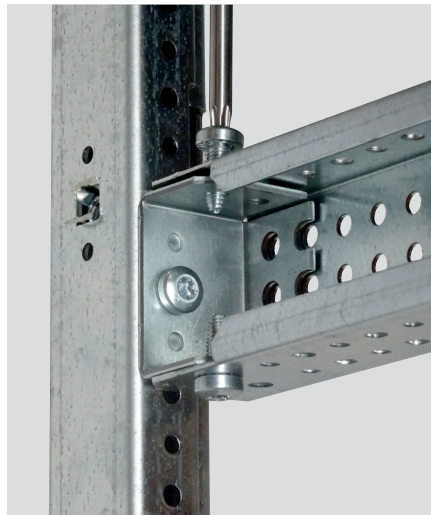

Repeat the process for the other crosspiece.

Then cut the 2 lateral functional uprights: take off 250 mm (200 mm for your free space + 50 mm crosspiece height).

Fix the 2 uprights fixing lugs as described above.

To sum up, you will have 200 mm of free space and 1500 mm of usable height for a 2000 mm enclosure or 1750 mm for a 2200 mm enclosure.

## ■ For a 300 mm free space :

- Fixing screws of the crosspieces lugs → 325 mm from the structure
- Uprights cut → 350 mm
- Usable height → 1450 mm (for a 2000 mm enclosure) or 1650 mm (for a 2200 mm). Identical mounting to apply according to the free space needed.

## 12 MOUNTING CENTRAL UPRIGHT

6 catalogue numbers are available :

Cat.No	Height	Width
3 381 60	2000 mm	450 mm
3 381 61		600 mm
3 381 62		800 mm
3 381 63	2200 mm	450 mm
3 381 64		600 mm
3 381 65		800 mm

### ■ Composition

1 central upright, 4 fixing lugs, 2 crosspieces, and 16 self-tapping screws.

Horizontal mounting only.

Position the upper and lower crosspieces respecting the installation direction (small edge at the front of the enclosure).



Check the hole on the front of the enclosure is placed at 175 mm from the inner structure's upright.

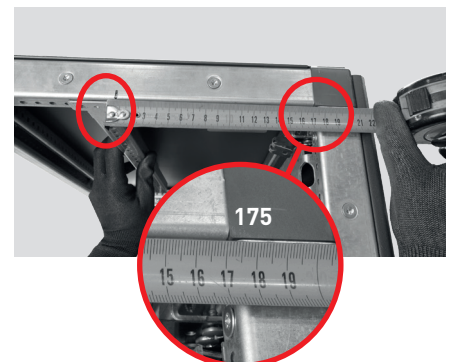



Fix the upper and lower crosspieces using the self-tapping screws provided (4 screws per crosspiece) → Torx S30 end-piece, tightening torque 8 N.m.



Position the 4 fixing lugs (2 at the top and 2 at the bottom) at the same lateral level as the rectangular-shaped holes at the back of the crosspieces: pay attention to the installation direction (see picture). Fix these 4 fixing lugs using the self-tapping screws provided (1 per lug) → Torx S30 end-piece, tightening torque 8 N.m.

Put in place the central upright in the fixing lugs, then secure using the self-tapping screws provided (1 per lug) → Torx S30 end-piece, tightening torque 8 N.m.

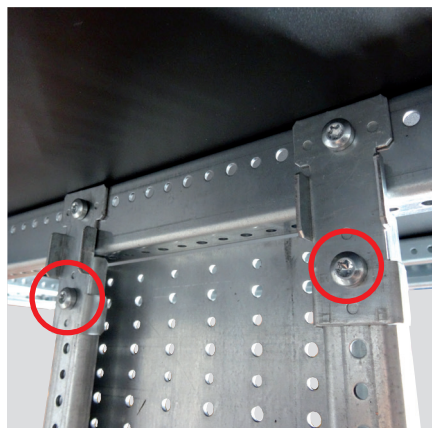

Insert the crosspiece in the 2 lugs then fix using 2 screws Torx S30 (tightening torque 5 N.m.).

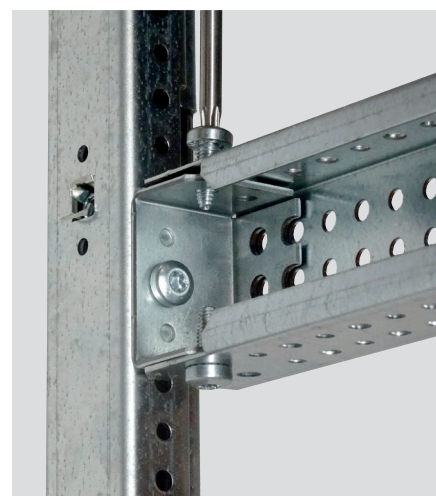

Repeat the process for the other crosspiece.



**You can also keep a free space at the top or at the bottom of the enclosure to:**

- Facilitate the installation of the main power
- Put in place a DMX<sup>3</sup>

To succeed, you need to get a set of crosspieces, catalogue number 3 397 34 (depth 400 mm) or 3 397 35 (depth 600 mm) or 3 397 36 (depth 800 mm).

To keep a 200 mm free space, position the fixing screws of your 2 crosspiece's lugs at 225 mm from the structure (Torx S30 end-piece, tightening torque 5 N.m.)

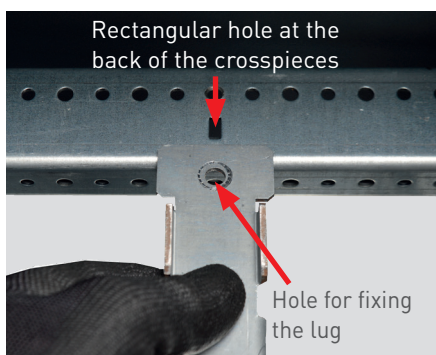

# XL<sup>3</sup> S 4000 ENCLOSURES

Then cut the left and right parts from one of the central crosspieces (the one located at the closest of the free space).

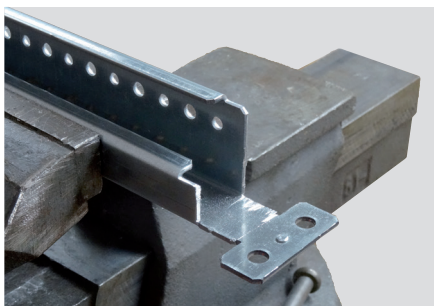
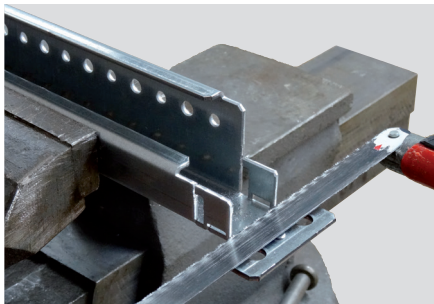
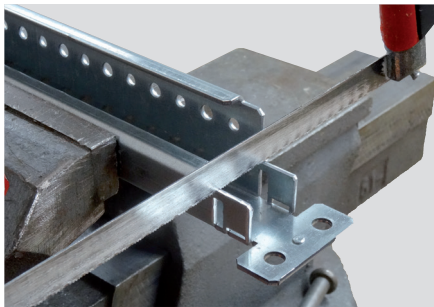

Mount the crosspiece respecting the 175 mm of the 1st screw from the inner structure's upright of the front of the enclosure.

The 2nd crosspiece and the central upright's lugs need to be mounted as previously explained.

Then cut the central functional upright: remove 250 mm (200 mm of free space + 50 mm of crosspiece height).

**!** Cut while respecting the line pre-defined at the bottom of the holes (at the closest of the value desired) → if this recommendation is not respected, the central upright will not fit between the crosspieces.

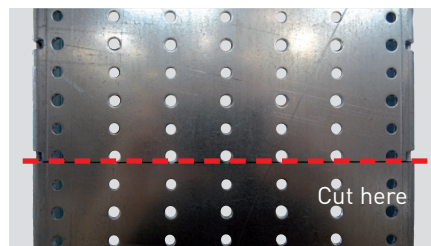

Put in place the central upright as described previously.

To sum up, you will have 200 mm of free space and 1500 mm of usable height for a 2000 mm enclosure or 1750 mm for a 2200 mm enclosure.

### For a 300 mm free space :

- Fixing screws of the crosspieces lugs → 325 mm from the structure
- Uprights cut → 350 mm
- Usable height → 1450 mm (2000 mm enclosure), 1650 mm (2200 mm enclosure).

Identical mounting to apply according to the free space needed.

### Example of a 200 mm free space :



## 13 DOORS MOUNTING



Doors are reversible, they can be opened on the left or on the right. You need: to change the position of the locks and hinges, turn 180° the door and the handle. Their hinges allow a 180° opening.

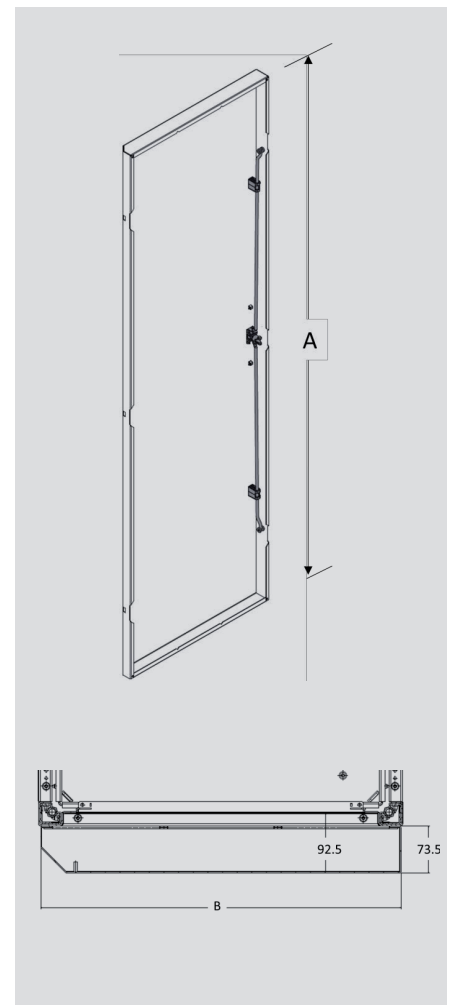

METALLIC DOORS			
Cat.No	A (mm)	B (mm)	Enclosure
3 381 00	1872	318	3 380 00
			3 380 04
			3 380 08
			3 380 09
3 381 01	418	318	3 380 01
			3 380 05
3 381 02	568	418	3 380 02
			3 380 06
3 381 03	768	418	3 380 03
			3 380 07
3 381 10	2072	318	3 380 20
			3 380 24
			3 380 28
			3 380 29
3 381 11	418	318	3 380 21
			3 380 25
3 381 12	568	418	3 380 22
			3 380 26
3 381 13	768	418	3 380 23
			3 380 27
			3 380 31

GLASS DOORS				
Cat.No	A (mm)	B (mm)	Dim. glass	Enclosure
3 381 20	1872	418	1770 x 270	3 380 01
				3 380 05
				3 380 09
3 381 21	568	418	1770 x 420	3 380 02
				3 380 06
				3 380 10
3 381 22	768	418	1770 x 620	3 380 03
				3 380 07
3 381 30	2072	418	1970 x 270	3 380 21
				3 380 25
				3 380 29
3 381 31	568	418	1970 x 420	3 380 22
				3 380 26
3 381 32	768	418	1970 x 620	3 380 23
				3 380 27
				3 380 31

### ■ Composition

1 door, 3 locks, 3 hinges and axes, 1 locking handle with the key, 2 securing clips, 1 plastic cover, 6 cage-nuts, 6 screws and 2 links system doors (with supports).



**!** Identify the need if it opens on the left or on the right, before starting the any mounting.

After having identified the opening need (left or right), you need to install the handle as well as the link system door.

- Put in place the handle by clipping it (at the opposite of the hinges) with the mechanical part (facing upward) as well as the plastic cover in the dedicated empty hole above.



- Insert each link system door in a black plastic support respecting the installation direction. .





# XL<sup>3</sup> S 4000 ENCLOSURES

- Insert properly at a maximum of 2 supports in the door's studs then push down the upper support and push up the lower support to lock the whole.

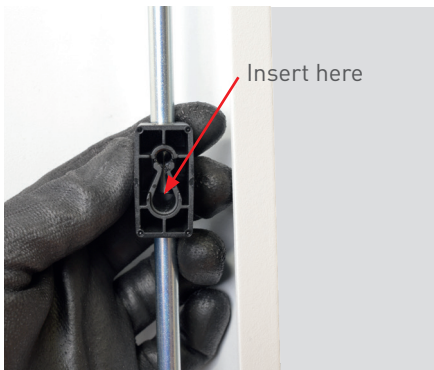

Push down (upper support).

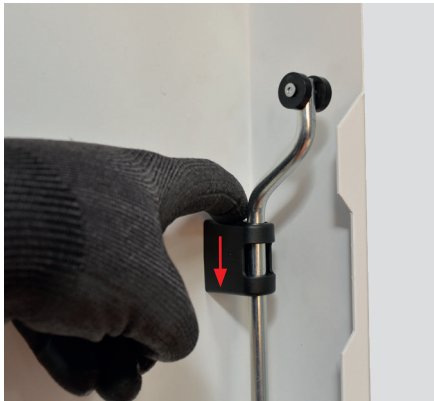

- Insert the 2 links system doors in the handle's studs and put in place the 2 securing clips to lock the whole.



Overview of the right position.



- Put in place the 6 cage-nuts in the square-shaped holes of the enclosure (hinges' side).



- Fix the 3 hinges and the 3 locks (at the opposite of the hinges) on the enclosure using the screws provided: Pozidriv n°3, tightening torque 8 N.m.

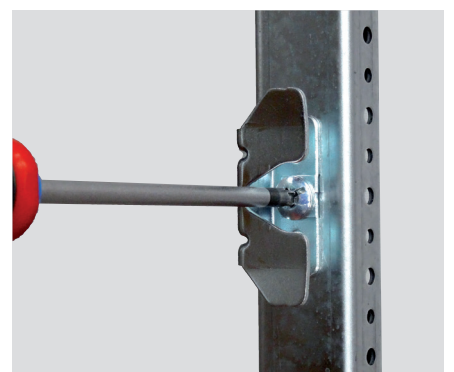

- Insert the door in the hinges then secure the whole using the pins provided.



- Close the door and test the opening/ closing.

Vertical key:  
the door is open (not out of service) .



Horizontal key:  
the door is closed (out of service) .



#### 14 FRONT PANEL SUPPORT

Front panel supports should be put in place only when the enclosure is fully equipped (plates, products, rails among others).

Cat.No	Height
3 381 56	2000 mm
3 381 58	2200 mm

#### ■ Composition

2 faceplate supports and 8 countersunk head self-tapping screws (4 per side).

Position the faceplate supports in the right installation direction and fix using the Torx S30 screws provided → tightening torque 5 N.m.



## 15 INDIVIDUAL FACEPLATE

2 different types of faceplate's fixation:

### ■ Via ¼ turn screws (catalogue number 3 397 01, set of 100)

Insert the cage nuts into the stud. Use a mallet to push it in properly.

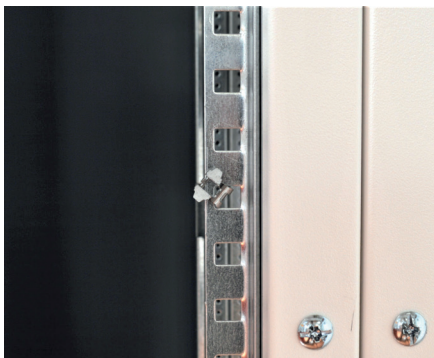

Position the ¼ turn screws in the door with the black washers and secure it by turning a quarter turn.



### ■ Via screws (catalogue number 3 397 02, set of 100)

Each catalogue number is composed of 100 screws, 100 plastic washers, 100 clips and 25 claws.

- Insert the screws in the square-shaped holes of the faceplate and place at the back the plastic washers.



- Put in place the right number of clips on the faceplate support.



- Insert a claw 30 mm lower than one of the 2 clips at the top.

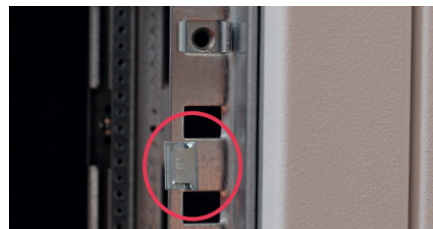

- Fix the faceplate while tightening the screws → Pozidriv n°3, tightening torque 5 N.m.

## 16 DOORS EQUIPOTENTIAL LINK, SIDE PANELS AND FACEPLATES (CAT.NO 3 397 53)

**!** When mounting inside the enclosure, make sure to always use the largest holes (Ø 5.4 mm) to fix the equipment. The smallest holes (Ø 4.6 mm) are used to insert anti-rotation studs.

### ■ Composition

- 1 green/yellow cable equipped with 2 lugs ;
- 1 self-tapping screw ;
- 1 15 mm metric screw ;
- 1 toothed washer for M6 screws ;
- 1 toothed washer for M5 screws ;
- 4 flat washers.

### ■ Mounting the equipotential link on a door:

The faceplates and lateral panels equipotential is ensured by the accessories for fixing (and the claw for faceplates). As well, the doors equipotential link is automatically made via the hinges.

When mounting electrical equipment of which the operating voltage exceeds 50V, on the door, faceplates or side panels, it is required to make a complementary equipotential link. You must use the conductor catalogue number 3 397 53. The length of the conductor is 350 mm, its section is 6 mm<sup>2</sup>.

For the cable passage (and maybe the wiring) we recommend to put in place a faceplate (either at the top or at the bottom of the enclosure) equipped with a membrane gland Plexo.

Several diameters are available: 20 mm maximum [Cat.No 0 919 08/14], 25 mm maximum [Cat.No 0 919 00/15], 32 mm maximum [Cat.No 0 919 16] and 40 mm maximum [Cat.no 0 919 17].



- Drill a hole in the faceplate at the adapted diameter according to the membrane gland.
- Position the membrane gland.
- Use the self-tapping screw and the flat washer and fix a cable's end on the structure's crosspiece of the enclosure.
- Insert the cable through the membrane gland.
- Fix the faceplate on the supports.
- Remove the protecting cover from the door's stud.
- Position the other cable's end in the stud, the washer, the nut and secure the whole.



■ **Mounting the equipotential link on a side panel :**

- Use a flat plier and twist/bend the adapted lug on the faceplate.
- Use the metric screw equipped with a toothed washer and insert the whole in the lug's hole.
- On the other side, place a cable's end, then the 2nd toothed washer and the nut.

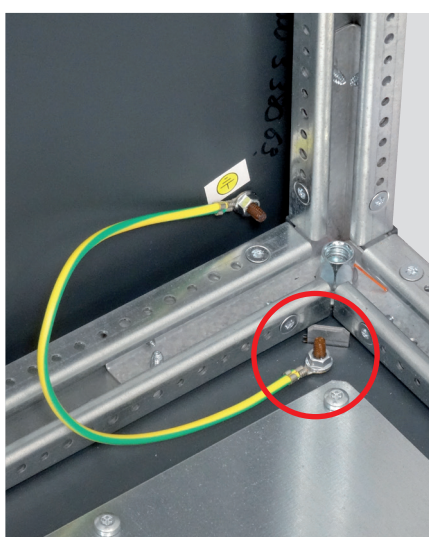

- If the lug is missing at the bottom of the enclosure, use the self-tapping screw and a flat washer then fix it with the other cable end on the crosspiece.

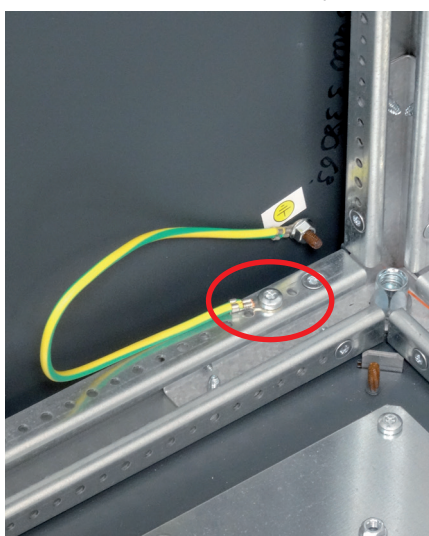

■ **Mounting the equipotential link on a faceplate :**

- Use a flat plier and twist/bend the adapted lug on the faceplate.

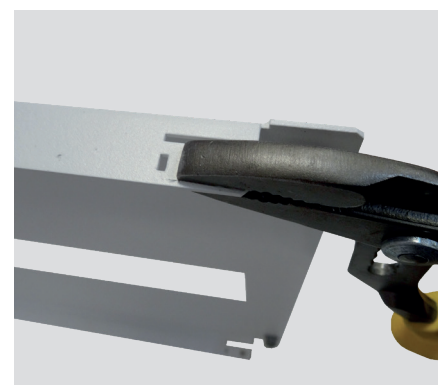

- Use the metric screw equipped with a toothed washer and insert the whole in the lug's hole.
- On the other side, place a cable's end, then the 2nd toothed washer and the nut.
- Tighten, tightening torque 8 N.m.



- Use the self-tapping screw equipped with a flat washer and fix the other cable's end on the enclosure structure's rear upright.



# XL<sup>3</sup> S 4000 ENCLOSURES

## 17 INTERNAL CABLE SLEEVES KIT

**!** When mounting inside the enclosure, make sure to always use the largest holes (Ø 5.4 mm) to fix the equipment. The smallest holes (Ø 4.6 mm) are used to insert anti-rotation studs.

XL<sup>3</sup> S 4000 36 modules enclosures can be equipped with an internal cable sleeve. The latter can be installed either on the left or on the right.

Cat.No	Height
3 381 43	2000 mm
3 381 53	2200 mm

### ■ Composition

1 door, 1 intermediate structural upright, 1 faceplate support, 2 rounded head screws Torx S30, 16 countersunk head screws Torx S30, 2 handles, 2 holding clips for handles, 2 hinges, 2 fixing lugs and 2 membrane glands.

- Remove the protecting cover to ensure grounding continuity on the intermediate structural upright as well as the 2 membrane glands (top and bottom of the cable sleeve passage).

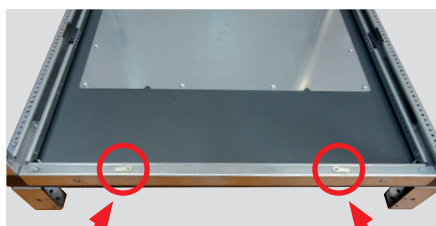

Rubber seal for cable sleeve on the left

Rubber seal for cable sleeve on the right

- Fix the 2 fixing lugs (top and bottom) using 2 rounded head screws, hole on the left for the cable sleeve on the left and hole on the right for the cable sleeve on the right → Torx S30 end-piece, tightening torque 5 N.m.

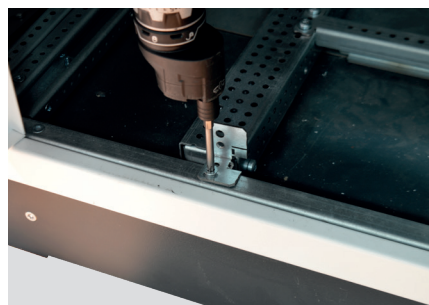
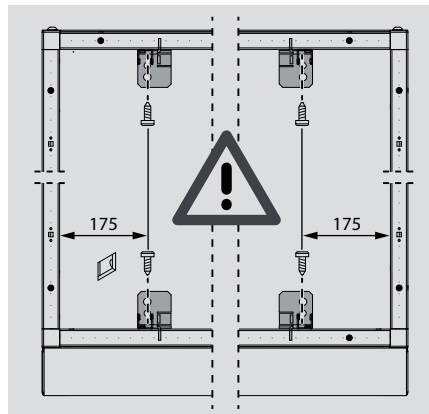

- Insert the intermediate structural upright in the lugs respecting the installation direction: the largest side towards the cable sleeve.

- Use 1 countersunk head screws per lug → Torx S30, tightening torque 5 N.m.

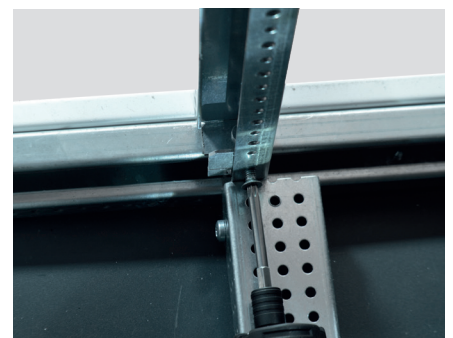

- Use 2 countersunk head screws to fix the 2 hinges on the frame → Torx S30 end-piece, tightening torque 5 Nm.



- Use 2 countersunk head screws to fix the door on the hinges → Torx S30 end-piece and 2 nuts/frame → 8 mm flat key, tightening torque 5 N.m.

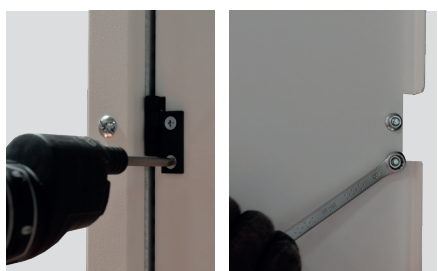

- Insert 2 protecting membrane glands (at the top and at the bottom) on the door.



- Put in place the equipotential link conductor, Cat.No 3 397 53, if needed after having removed the protecting cover from the door's stud.

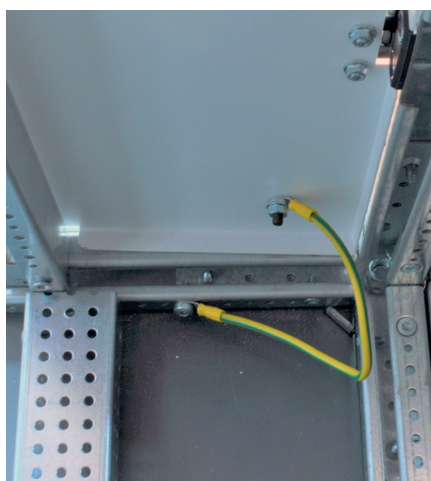

## 18 FLOOR FIXATION

To succeed, the floor needs to be levelled and free of roughness and of any relief (must be inclined by 1% maximum, lengthwise and widthwise).

The enclosure must be fixed to the floor using expansion plugs: check the instructions regarding the products adapted to the floor, respect a minimum  $\varnothing$  8 mm and a maximum  $\varnothing$  10 mm for the plugs screws (or studs thread).

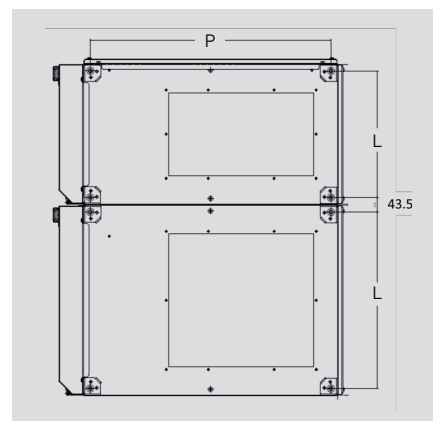

Cat.No	Lenght (mm)	Depth (mm)
3 380 00	281	331
3 380 20		531
3 380 04		731
3 380 24		
3 380 08	381	331
3 380 01		531
3 380 21		731
3 380 25		
3 380 09	531	331
3 380 02		531
3 380 22		731
3 380 26		
3 380 10	731	331
3 380 03		531
3 380 23		731
3 380 07		
3 380 27		
3 380 11		731
3 380 31		

# MOUNTING DEVICES

## 1 PRINCIPLE OF VOLUMES DEFINITION

Each device after being fixed on a rail, plate or busbars has a dedicated faceplate. Its height defined the volume needed in order to install other devices, to ease the connection, to respect the isolating distance as well as the perfect conditions of heat dissipation. When positioned, faceplates guarantee the IP 30 protection rate.

Several heights are available:

- From 100 mm to 800 mm for protection and breaking devices.
- From 50 mm to 600 mm for plain faceplates (excluding cable sleeves). The latter facilitate the circulation of conductors, the cable passage, the installation of busbars and specific equipment implementation.



When mounting inside the enclosure, make sure to always use the largest holes ( $\varnothing$  5.4 mm) to fix the equipment. The smallest holes ( $\varnothing$  4.6 mm) are used to insert anti-rotation studs.

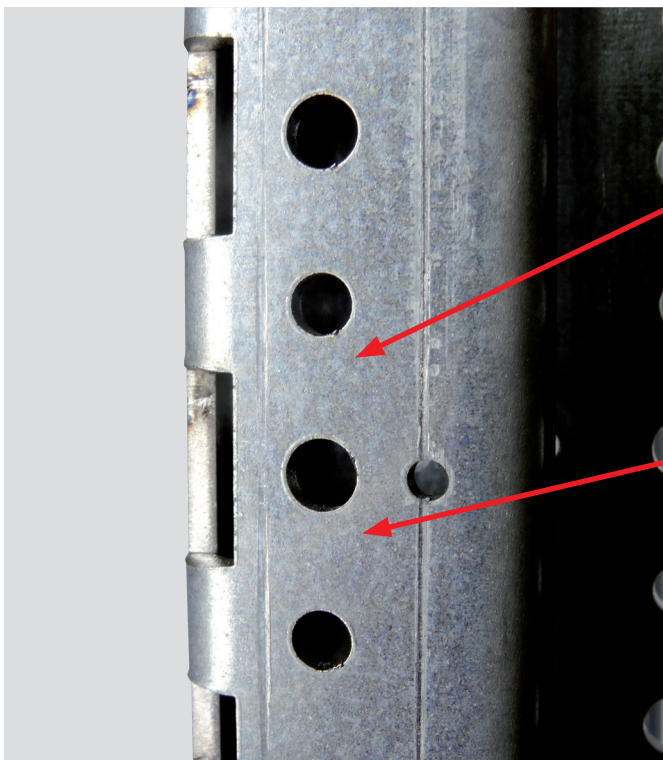

Holes for anti-rotation studs  $\varnothing$  4,6 mm

Holes for fixing the equipment  $\varnothing$  5,4 mm

DEVICE	ENCLOSURE	POSITION	CONFIGURATION	FIXING ACCESSORIES			FACEPLATES HEIGHT (MM)			
				RAIL	PLATE	BRACKETS				
MODULAR CIRCUIT BREAKERS	Width 16 mod.	Vertical	-	3 382 20	-	-	150	3 382 51		
	Width 24 mod.			3 382 23				3 382 52		
	Width 36 mod.			3 382 26				3 382 53		
DRX 125	Width 16 mod.	Vertical	1P	3 382 20 + 0 271 89	-	-	300	3 382 71		
	Width 24 mod.		2P	3 382 23 + 0 271 90				3 382 72		
	Width 36 mod.		3P and 4P	3 382 26 + 0 271 87				3 382 73		
DRX 125 HP	Width 16 mod.	Horizontal	3P	-	3 385 00	-	100	3 383 50		
	Width 16 mod.		4P	-	3 385 01	-	150	3 383 51		
	Width 24 mod.		3P	-	3 385 03	-	100	3 383 53		
	Width 24 mod.		4P	-	3 385 04	-	150	3 383 54		
	Width 36 mod.		3P	-	3 385 06	-	100	3 383 56		
	Width 36 mod.		4P	-	3 385 07	-	150	3 383 57		
	Width 16 mod.	Vertical	3P/4P	-	3 385 21	-	250	3 382 61		
	Width 24 mod.		3P	-	3 385 23	-	250	3 382 62		
	Width 24 mod.		4P	-	3 385 24	-	250	3 382 62		
	Width 36 mod.		3P	-	3 385 26	-	250	3 382 63		
	Width 36 mod.		4P	-	3 385 27	-	250	3 382 63		
	DPX <sup>3</sup> 125 HP		Width 16 mod.	Horizontal	3P	-	3 385 00	-	100	3 385 50
			Width 16 mod.		4P	-	3 385 01	-	150	3 385 51
			Width 24 mod.		3P	-	3 385 03	-	100	3 385 53
Width 24 mod.		4P	-		3 385 04	-	150	3 385 54		
Width 36 mod.		3P	-		3 385 06	-	100	3 385 56		
Width 36 mod.		4P	-		3 385 07	-	150	3 385 57		
Width 16 mod.		Vertical	3P/4P	-	3 385 21	-	250	3 385 71		
Width 24 mod.			3P	-	3 385 23	-	250	3 385 73		
Width 24 mod.			4P	-	3 385 24	-	250	3 385 74		
Width 36 mod.			3P	-	3 385 26	-	250	3 385 76		
Width 36 mod.		4P	-	3 385 27	-	250	3 385 77			

# MOUNTING DEVICES

DEVICE	ENCLOSURE	POSITION	CONFIGURATION	FIXING ACCESSORIES			FACEPLATES HEIGHT (MM)	
				RAIL	PLATE	BRACKETS		
DPX <sup>3</sup> 160	Width 16 mod.	Vertical	No side motor drive	3 382 20 + 4 210 71	-	-	300	3 382 71
			With earth leakage module - no motor drive	3 382 20 + 4 210 73				
			Side motor drive	3 382 20 + 4 210 68				
	Width 24 mod.	Vertical	No side motor drive	3 382 23 + 4 210 71	-	-	300	3 382 72
			With earth leakage module - no motor drive	3 382 23 + 4 210 73				
			Side motor drive	3 382 23 + 4 210 68				
	Width 36 mod.	Vertical	No side motor drive	3 382 26 + 4 210 71	-	-	300	3 382 73
			With earth leakage module - no motor drive	3 382 26 + 4 210 73				
			Side motor drive	3 382 26 + 4 210 68				
	Width 16 mod.	Horizontal / side panels	3P	-	3 383 00	-	150	3 383 51
	4P with or without earth leakage		3 383 01					
	Width 24 mod.	Horizontal / side panels	3P	-	3 383 04	-	150	3 383 54
	4P with or without earth leakage		3 383 04					
	Width 36 mod.	Horizontal / side panels	3P	-	3 383 07	-	150	3 383 57
			4P with or without earth leakage		3 383 07			
	Width 16 mod.	Horizontal / central panel	3P	-	3 396 20	-	100	3 383 50
			4P with or without earth leakage		3 396 10		150	3 383 51
	Width 24 mod.	Horizontal / central panel	3P	-	3 396 20	-	100	3 383 53
			4P with or without earth leakage		3 396 10		150	3 383 54
	Width 36 mod.	Horizontal / central panel	3P	-	3 396 20	-	100	3 383 56
			4P with or without earth leakage		3 396 10		150	3 383 57
	Width 16 mod.	Vertical	3P or 4P	-	3 383 20	-	300	3 382 71
			4P with earth leakage		3 383 21			
	Width 24 mod.	Vertical	3P	-	3 383 23	-	300	3 382 72
			4P		3 383 24			
			4P with earth leakage		3 383 25			
	Width 36 mod.	Vertical	3P	-	3 383 26	-	300	3 382 73
4P			3 383 27					
4P with earth leakage			3 383 28					
Width 16 mod.	Vertical	3P / 4P with rotary handle	-	3 383 80	-	300	3 383 83	
Width 24 mod.		3P / 4P with rotary handle	-	3 383 81	-	300	3 383 84	
Width 36 mod.		3P / 4P with rotary handle	-	3 383 82	-	300	3 383 85	

DEVICE	ENCLOSURE	POSITION	CONFIGURATION	FIXING ACCESSORIES			FACEPLATES HEIGHT (MM)	
				RAIL	PLATE	BRACKETS		
DPX <sup>3</sup> 250	Width 16 mod.	Vertical	No side motor drive	3 382 20 + 4 210 72	-	-	300	3 382 71
			With earth leakage module - no motor drive	3 382 20 + 4 210 74				
			Side motor drive	3 382 20 + 4 210 69				
			With earth leakage and cover	3 382 20 + 4 210 74			400	3 382 81
	Width 24 mod.	Vertical	No side motor drive	3 382 23 + 4 210 72	-	-	300	3 382 72
			With earth leakage module - no motor drive	3 382 23 + 4 210 74				
			Side motor drive	3 382 23 + 4 210 69				
			With earth leakage and cover	3 382 23 + 4 210 74			400	3 382 82
	Width 36 mod.	Vertical	No side motor drive	3 382 26 + 4 210 72	-	-	300	3 382 73
			With earth leakage - no motor drive	3 382 26 + 4 210 74				
			Side motor drive	3 382 26 + 4 210 69				
			With earth leakage - no motor drive	3 382 26 + 4 210 74			400	3 382 83
	Width 16 mod.	Horizontal / side panels	3P 3P or 4P with or without earth leakage	-	-	-	150	3 384 50
	Width 24 mod.						200	3 384 51
	Width 36 mod.						150	3 384 53
	Width 24 mod.	Horizontale / central panels	3P 4P with or without earth leakage	-	-	-	200	3 384 54
	Width 36 mod.						150	3 384 56
	Width 16 mod.						200	3 384 57
	Width 16 mod.						150	3 384 50
	Width 24 mod.						200	3 384 51
	Width 24 mod.						150	3 384 53
	Width 36 mod.						200	3 384 54
	Width 36 mod.	150	3 384 56					
	Width 36 mod.	200	3 384 57					
	Width 16 mod.	Vertical	3P or 4P 4P with earth leakage	-	-	-	300	3 382 71
	Width 24 mod.							
	Width 24 mod.						3 384 21	
							3 384 23	
	Width 24 mod.						3 384 24	
							3 384 25	
Width 36 mod.	3 384 26							
	3 384 27							
Width 36 mod.	3 384 28							
	3 382 72							
Width 36 mod.	3 382 73							
Width 16 mod.	Vertical	3P / 4P with rotary handle	-	-	-	300	3 383 83	
Width 24 mod.						300	3 383 84	
Width 36 mod.						300	3 383 85	

# MOUNTING DEVICES

DEVICE	ENCLOSURE	POSITION	CONFIGURATION	FIXING ACCESSORIES			FACEPLATES HEIGHT (MM)			
				RAIL	PLATE	BRACKETS				
DRX 250	Width 16 mod.	Vertical	All types	-	-	-	300	3 382 20 + 0 271 88	3 382 71	
	Width 24 mod.							3 382 23 + 0 271 88	3 382 72	
	Width 36 mod.							3 382 26 + 0 271 88	3 382 73	
DRX 250 HP	Width 16 mod.	Horizontal	3P	-	-	-	150	3 386 01 <sup>(1)</sup> / 3 396 24 <sup>(2)</sup>	3 384 50	
			4P with or without earth leakage					3 386 01 <sup>(1)</sup> / 3 396 16 <sup>(2)</sup>	200	3 384 51
	Width 24 mod.		3P					3 386 04 <sup>(1)</sup> / 3 396 24 <sup>(2)</sup>	150	3 384 53
			4P with or without earth leakage					3 386 04 <sup>(1)</sup> / 3 396 16 <sup>(2)</sup>	200	3 384 54
	Width 36 mod.		3P					3 386 07 <sup>(1)</sup> / 3 396 24 <sup>(2)</sup>	150	3 384 56
			4P with or without earth leakage					3 386 07 <sup>(1)</sup> / 3 396 16 <sup>(2)</sup>	200	3 384 57
	Width 16 mod.	Vertical	3P	-	-	-	300	3 386 20	3 382 71	
			4P with or without earth leakage					3 386 21	3 382 72	
			3P					3 386 23		
			Width 24 mod.					4P with or without earth leakage	3 386 24	
			Width 36 mod.					3P	3 386 26	3 382 73
								4P with or without earth leakage	3 386 26	
DPX <sup>3</sup> 250 HP	Width 16 mod.	Horizontal	3P	-	-	-	150	3 386 01 <sup>(1)</sup> / 3 396 24 <sup>(2)</sup>	3 386 50	
			4P with or without earth leakage					3 386 01 <sup>(1)</sup> / 3 396 16 <sup>(2)</sup>	200	3 386 51
	Width 24 mod.		3P					3 386 04 <sup>(1)</sup> / 3 396 24 <sup>(2)</sup>	150	3 386 53
			4P with or without earth leakage					3 386 04 <sup>(1)</sup> / 3 396 16 <sup>(2)</sup>	200	3 386 54
	Width 36 mod.		3P					3 386 07 <sup>(1)</sup> / 3 396 24 <sup>(2)</sup>	150	3 386 56
			4P with or without earth leakage					3 386 07 <sup>(1)</sup> / 3 396 16 <sup>(2)</sup>	200	3 386 57
	Width 16 mod.	Vertical	3P	-	-	-	300	3 386 20	3 386 70	
			4P with or without earth leakage					3 386 21	3 386 71	
			3P					3 386 23	3 386 73	
			Width 24 mod.					4P with or without earth leakage	3 386 24	3 386 74
			Width 36 mod.					3P	3 386 26	3 386 76
								4P with or without earth leakage	3 386 27	3 386 77

(1) : On side panels  
 (2) : On central panels



DEVICE	ENCLOSURE	POSITION	CONFIGURATION	FIXING ACCESSORIES			FACEPLATES HEIGHT (MM)		
				RAIL	PLATE	BRACKETS			
DPX <sup>3</sup> 630	Width 16 mod.	Vertical	3P/4P with rotary handle	-	3 383 86	-	400	3 383 92	
	Width 24 mod.		3P/4P with rotary handle	-	3 383 87	-	400	3 383 93	
	Width 36 mod.		3P/4P with rotary handle	-	3 383 88	-	400	3 383 94	
	Width 16 mod.		3P/4P with motor drive	-	3 383 89	-	400	3 383 92	
	Width 24 mod.		3P/4P with motor drive	-	3 383 90	-	400	3 383 93	
	Width 36 mod.		3P/4P with motor drive	-	3 383 91	-	400	3 383 94	
	Width 16 mod.	Horizontal / side panels	3P	-	3 387 01	-	200	3 387 51	
			4P					3 387 54	
	Width 24 mod.		3P					3 387 04	3 387 57
	Width 36 mod.		4P					3 387 07	
	Width 16 mod.	Horizontal / central panels	3P	-	3 396 22	-	150	3 387 50	
			4P with or without earth leakage		3 396 12		200	3 387 51	
	Width 24 mod.		3P		3 396 22		150	3 387 53	
			4P with or without earth leakage		3 396 12		200	3 387 54	
	Width 36 mod.		3P		3 396 22		150	3 387 56	
			4P without earth leakage		3 396 12		200	3 387 57	
		4P with earth leakage	3 396 12	200	3 387 58				
	Width 16 mod.	Vertical	3P / 4P without earth leakage	-	3 387 20	-	400	3 387 70	
			4P with earth leakage		3 387 21		600	3 387 71	
	Width 24 mod.		3P / 4P without earth leakage		3 387 24		400	3 387 74	
			4P with earth leakage		3 387 25		600	3 387 75	
	Width 36 mod.		3P / 4P without earth leakage		3 387 27		400	3 387 77	
			4P with earth leakage		3 387 28		600	3 387 78	

# MOUNTING DEVICES

DEVICE	ENCLOSURE	POSITION	CONFIGURATION	FIXING ACCESSORIES			FACEPLATES HEIGHT (MM)	
				RAIL	PLATE	BRACKETS		
DPX-IS 630	Width 24 mod.	Horizontal / side panels	3P or 4P	-	3 390 02	-	300	3 390 41
	Width 36 mod.				Horizontal / side panels			3P or 4P
		Vertical	Horizontal / central panels				3P	3 396 14
	Width 16 mod.		3P or 4P		3 390 20		400	3 390 50
	Width 24 mod.		3P or 4P		3 390 22			3 390 52
	Width 36 mod.		3P or 4P		3 390 24			3 390 54
DPX <sup>3</sup> 1600	Width 24 mod.	Horizontal	3P		3 388 01		300	3 388 41
			4P		3 388 02		400	3 388 42
	Width 36 mod.		3P		3 388 03		300	3 388 43
			4P		3 388 04		400	3 388 44
	Width 16 mod.	Vertical	3P	-	3 388 10	-		3 388 50
	Width 24 mod.		3P / 4P		3 388 12		350	3 388 52
Width 36 mod.	3P / 4P			3 388 14			3 388 54	
DPX-IS 1600	Width 24 mod.	Horizontal	3P		3 388 01		300	3 388 61
			4P		3 388 02		400	3 388 62
	Width 36 mod.		3P		3 388 03		300	3 388 63
			4P		3 388 04		400	3 388 64
	Width 16 mod.	Vertical	3P	-	3 388 10	-		3 388 70
	Width 24 mod.		3P / 4P		3 388 12		350	3 388 72
Width 36 mod.	3P / 4P			3 388 14			3 388 74	

DEVICE	ENCLOSURE	POSITION	CONFIGURATION	FIXING ACCESSORIES			FACEPLATES HEIGHT (MM)	
				RAIL	PLATE	BRACKETS		
SPX 000	Width 16 mod.	Vertical	3P	-	3 392 60	-	300	3 392 70
	Width 24 mod.				3 392 61			3 392 71
	Width 36 mod.				3 392 62			3 392 72
SPX 00	Width 16 mod.	Vertical	3P	-	3 392 60	-	300	3 393 00
	Width 24 mod.				3 392 61			3 393 01
	Width 36 mod.				3 392 62			3 393 02
SPX 1	Width 16 mod.	Vertical	3P	-	3 393 20	-	400	3 393 30
	Width 24 mod.				3 393 21			3 393 31
	Width 36 mod.				3 393 22			3 393 32
SPX 2	Width 16 mod.	Vertical	3P	-	3 393 50	-	400	3 393 60
	Width 24 mod.				3 393 51			3 393 61
	Width 36 mod.				3 393 52			3 393 62
SPX 3	Width 24 mod.	Vertical	3P	-	3 393 81	-	400	3 393 91
	Width 36 mod.				3 393 82			3 393 92

# MOUNTING DEVICES

DEVICE	ENCLOSURE	POSITION	CONFIGURATION	FIXING ACCESSORIES			FACEPLATES HEIGHT (MM)			
				RAIL	PLATE	BRACKETS				
				FIXATION SUR JEUX DE BARRES						
SPX 000	Width 16 mod.	Vertical	3P	-	-	3 392 50	300	3 392 70		
	Width 24 mod.							3 392 71		
	Width 36 mod.							3 392 72		
SPX 00	Width 16 mod.	Vertical	3P	-	-	3 392 50	300	3 393 00		
	Width 24 mod.							3 393 01		
	Width 36 mod.							3 393 02		
SPX 1	Width 16 mod.	Vertical	3P	-	-	3 392 50	400	3 393 30		
	Width 24 mod.							3 393 31		
	Width 36 mod.							3 393 32		
SPX 2	Width 24 mod.	Horizontal <sup>(1)</sup>	3P	-	-	3 392 50	500	3 393 65		
	Width 36 mod.	Horizontal <sup>(2)</sup>						3 393 66		
	Width 16 mod.	Vertical					400	3 393 60		
	Width 24 mod.	Vertical						3 393 61		
	Width 36 mod.	Vertical						3 393 62		
SPX 3	Width 24 mod.	Horizontal <sup>(1)</sup>	3P	-	-	3 392 50	500	3 393 95		
	Width 36 mod.	Horizontal <sup>(2)</sup>						3 393 96		
	Width 24 mod.	Vertical					400	3 393 91		
	Width 36 mod.	Vertical						3 393 92		
SPX <sup>3</sup> -V	Width 36 mod.	Horizontal	-	-	-	3 394 51	600	3 394 54		
	Width 24 mod.	Vertical						3 394 40	800	(3)
	Width 36 mod.	Vertical						3 394 41	800	(3)

(1) : Crosspiece Cat.No 3 379 81

(2) : Crosspiece Cat.No 3 379 82

(3) : Provided with the reference of the fixing device

DEVICE	ENCLOSURE	POSITION	CONFIGURATION	FIXING ACCESSORIES			FACEPLATES HEIGHT (MM)	
				RAIL	PLATE	BRACKETS		
SPX-D 160	Width 16 mod.	Vertical	3P / 4P	-	3 394 60	-	300	3 394 71
	Width 24 mod.				3 394 61			3 394 73
	Width 36 mod.				3 394 62			3 394 75
SPX-D 250	Width 24 mod.	Vertical	3P / 4P	-	3 394 81	-	450	3 394 93
	Width 36 mod.				3 394 82			3 394 95
SPX-D 400	Width 24 mod.	Vertical	3P / 4P	-	3 394 81	-	450	3 394 93
	Width 36 mod.				3 394 82			3 394 95
SPX-D 630	Width 24 mod.	Vertical	3P / 4P	-	3 395 21	-	450	3 395 33
	Width 36 mod.				3 395 22			3 395 35
DMX <sup>3</sup> size 1600	Width 16 mod.	Fixed version	3P	-	3 391 01	-	600	3 391 20
	Width 24 mod.		3P / 4P		3 391 03			3 391 23
	Width 36 mod.		3P / 4P		3 391 05			3 391 25
	Width 16 mod.	Withdrawable version	3P		3 391 01			3 391 30
	Width 24 mod.		3P / 4P		3 391 03			3 391 33
	Width 36 mod.		3P / 4P		3 391 05			3 391 35
DMX <sup>3</sup> size 2500	Width 24 mod.	Fixed version / withdrawable	3P / 4P	-	3 391 43	-	600	3 391 63
	Width 36 mod.				3 391 45			3 391 65
DMX-SP size 2500	Width 24 mod.	Fixed version	3P / 4P	-	3 392 22	-	500	3 392 33
	Width 36 mod.	withdrawable version	3P / 4P	-	3 392 25	-	500	3 392 35
	Width 24 mod.	Fixed version	3P / 4P	-	3 392 22	-	500	3 392 43
	Width 36 mod.	withdrawable version	3P / 4P	-	3 392 25	-	500	3 392 45
DMX <sup>3</sup> size 4000/ DMX SP size 4000	Width 36 mod.	Fixed version / withdrawable	3P / 4P	-	3 391 85	-	600	3 392 05

(1) : Crosspiece Cat.No 3 379 81  
(2) : Crosspiece Cat.No 3 379 82

## 2 FIXATING OPTIONS: PLATE, RAILS, BUSBARS, AND PLAIN PLATE:

4 fixation systems are available:

### Plates :

- DPX<sup>3</sup> 160/250, DPX-IS 250
- DRX 250 HP
- DPX<sup>3</sup> 250 HP
- DPX<sup>3</sup> 630, DPX-IS 630
- DPX<sup>3</sup> 1600, DPX-IS 1600
- SPX 000/00/1/2/3
- SPX-D 160/250/400/630
- DMX<sup>3</sup> size 1600/2500/4000
- DMX SP size 2500/4000

### Rails :

- DPX<sup>3</sup> 160/250, DRX 125/250
- Modular devices
- SPX 000

### Busbars :

- SPX 000/00/1/2/3
- SPX<sup>3</sup>-V

### Perforated plates :

- CTX<sup>3</sup>
- MPX<sup>3</sup>
- Etc ...

### ■ Plates :

To mount devices, use clips-nuts, screws-nuts (all SPX000 products or directly screwing the products fixing screws on the plate).

- After having installed the product on the plate, it is required to bend the retaining brackets and then hang them on the enclosure's uprights.

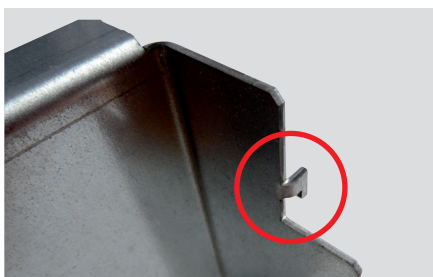

**XL Pro<sup>3</sup> software gives you automatically the position of the plates and rails, according to the configuration.**

Dimensions given by XL Pro<sup>3</sup> are calculated in relation to the 0-point located under the upper crosspieces of the main structure.



The right plates position is defined by the faceplate plan.

- Insert the plate's anti-rotation studs in the small holes of the enclosure's uprights, then position the auto-tapping screw provided and tighten: Torx S30 end piece → tightening torque 8 N.m. Repeat these 2 steps for the other fixation points (2 or 4).

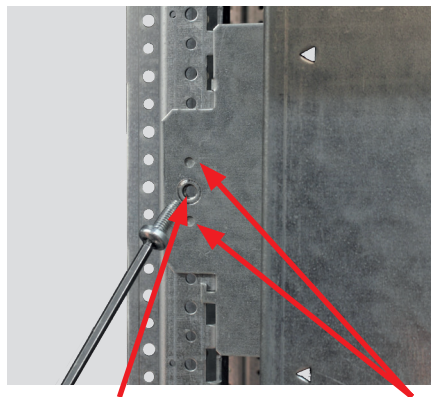

Hole for the fixing screw

Anti-rotation studs

### Universal plain and perforated plates

PLAIN PLATES				
Height	200 mm	300 mm	400 mm	600 mm
16 M	3 395 40	3 395 41	3 395 42	3 395 43
24 M	3 395 44	3 395 45	3 395 46	3 395 47
36 M	3 395 48	3 395 49	3 395 50	3 395 51
PERFORATED PLATES				
Height	200 mm	300 mm	400 mm	600 mm
16 M	3 395 60	3 395 61	3 395 62	3 395 63
24 M	3 395 64	3 395 65	3 395 66	3 395 67
36 M	3 395 68	3 395 69	3 395 70	3 395 71

Both are delivered with 2 self-tapping screws and need to be fixed on the functional uprights as a classic plate. The main differences are they have no anti-rotation studs and that 4 retaining brackets exist rather than only 2.

Example of the plate Cat.No 3 395 41 :

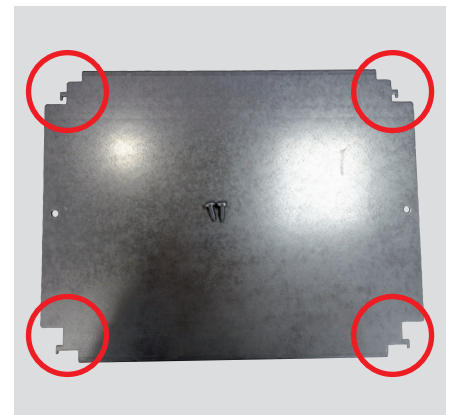



### ■ URails :

They can be adjusted; 3 different depths enable the mounting of: DPX<sup>3</sup> 160/250 and DRX 125/250.

#### 3 catalogue numbers exist:

- 3 382 20 : 16 modules
- 3 382 23 : 24 modules
- 3 382 26 : 36 modules

#### Composition :

- 1 rail
- 2 brackets
- 2 fixing lugs

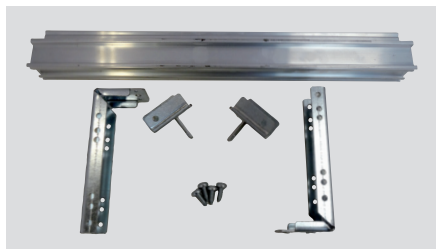

- Put in place the 2 metallic brackets on each side of the rail

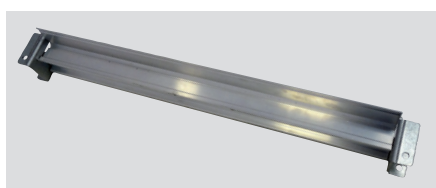
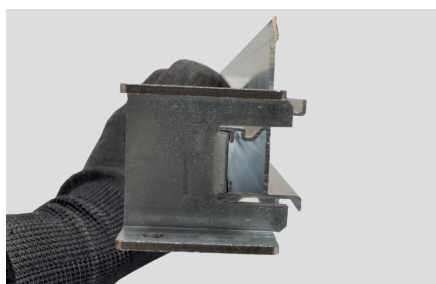

It is possible to fasten the fixing lugs on the lateral functional uprights as well as behind the front structural uprights of the enclosure.

On the lateral functional uprights :



Behind the front structural uprights :



Fixing lugs behind the front structural uprights enable an easier installation of ducts or other terminals on the back structural uprights → lugs can be cut to save space.

Depending on the type of products used on the rail, the space available between the rail and the back structural upright is :

- 95 mm when modular devices are on the rail
- 80 mm when a DRX is on the rail
- 70 mm when a DPX<sup>3</sup> is on the rail

Example of the part to cut in case there is a DPX<sup>3</sup> on the rail :

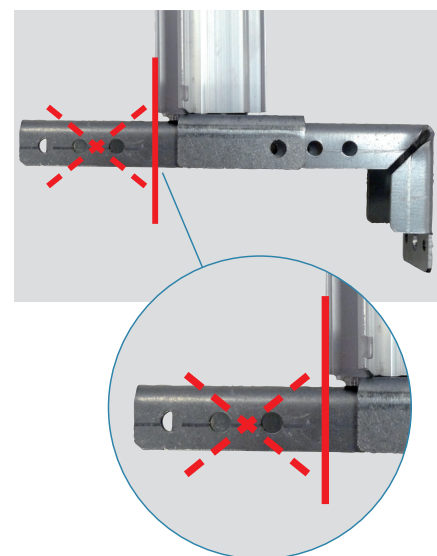

- Install the rail equipped with brackets on the fixation lugs depending on the configuration needed.

# MOUNTING DEVICES

Example of 3 possible configurations (mounting on lateral functional uprights)

Modular devices

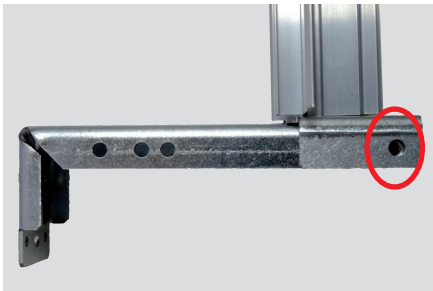

DRX

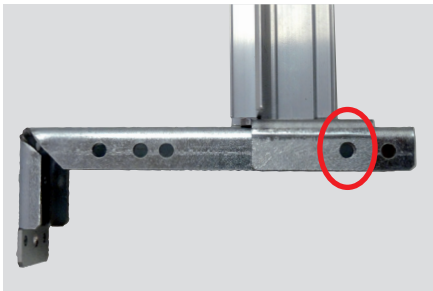

DPX<sup>3</sup>

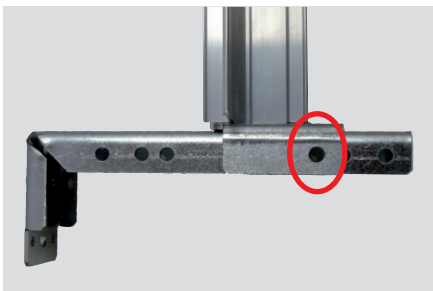

Example of 3 possible configurations (mounting behind the front structural uprights):

Modular devices

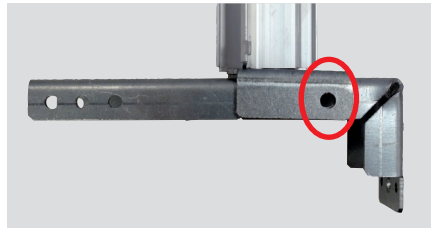

DRX

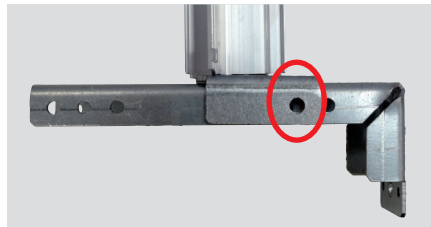

DPX<sup>3</sup>

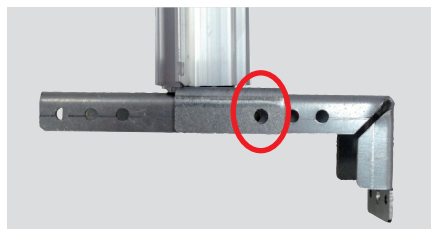

- Once the configuration and position are defined, secure the rail and lugs using self-tapping screws (one on each side) → Torx S30 end-piece, tightening torque 8 N.m.

**Example :**

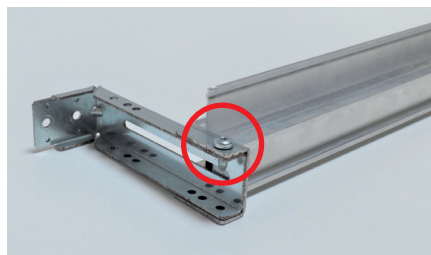

- Fix the whole on the back or front structural uprights (positioning correctly the anti-rotation studs) using 2 of the self-tapping screws provided (1 on each side) → Torx S30 screws, tightening torque 8 N.m.

**Lateral functional uprights :**

- The screws must be positioned in the inner holes of the lugs from the enclosure .

Example on the right side of the rail :

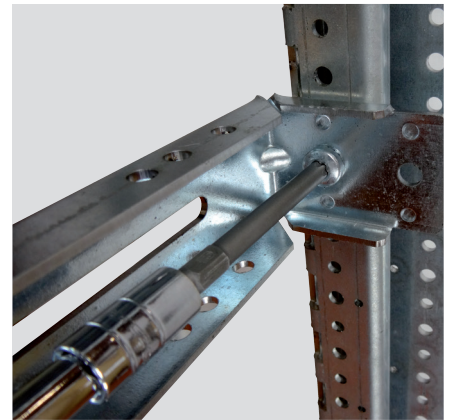

**Behind the front structural uprights :**

- The screws must be positioned in the outermost holes of the lugs from the enclosure .

Example on the right side of the rail :

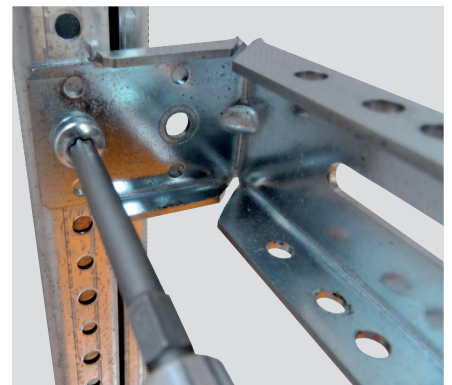

### ■ Rail height spacer

3 catalogue numbers enable the cohabitation of several products on the same rail:

#### Cat.No 3 382 40 :

Enables the cohabitation between modular devices and DPX<sup>3</sup> 160/250.

In the case, you must position the rail on the fixation lugs in the most deeper position.

#### Cat.No 3 382 41 :

Enables the cohabitation between modular devices and DRX 125/250.

In this case, you must position the rail in a intermediate position on the fixing lugs.

#### Cat.No 3 382 42 :

Enables the cohabitation between DPX<sup>3</sup> 160/250 and DRX 125/250.

In this case, you must position the rail on the fixing lugs in the most deeper position.

To fix the DPX<sup>3</sup> and DRX on the rail, it is required to equip them with a fixing plate, here are the catalogue numbers :

- 4 210 68 : for DPX<sup>3</sup> 160 with side motor drive
- 4 210 69 : for DPX<sup>3</sup> 250 with side motor drive
- 4 210 71 : for DPX<sup>3</sup> 160 without side motor drive
- 4 210 72 : for DPX<sup>3</sup> 250 without side motor drive
- 4 210 73 : for DPX<sup>3</sup> 160 with earth leakage module without side motor drive
- 4 210 74 : for DPX<sup>3</sup> 250 with earth leakage module without side motor drive
- 0 271 87 : for DRX 125 3P or 4P
- 0 271 88 : for all DRX 250
- 0 271 89 : for DRX 125 1P
- 0 271 90 : for DRX 125 2P

#### Plate for DPX<sup>3</sup>



#### Plate for DRX



The adapter for rail needs to be clipped on the rail. Depending on the configuration required, you can cut it if needed.

Example of mounting a rail height spacer  
Cat.No 3 382 40 :

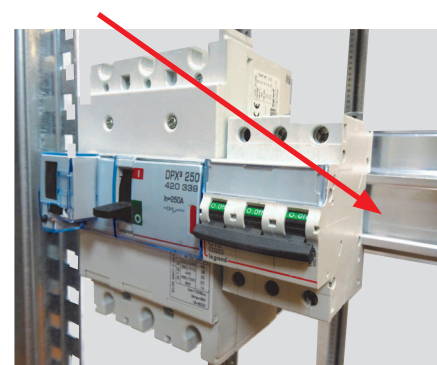

### ■ Set of busbars :

SPX and SPX<sup>3</sup>-V product ranges can be directly installed on busbars using fixing brackets and isolating supports.

Depending on the enclosure's configuration, these products can be mounted either on vertical or horizontal busbars (apart from the SPX 000, to mount only on horizontal busbars).

# MOUNTING DEVICES

## ■ Plain plate :

Plain plates offer a great freedom of installation regarding MPX<sup>3</sup> or CTX<sup>3</sup> products. It enables to use all the height available to mount control and non-modular automatism products.

4 catalogue numbers are available :

Cat.No	Height (mm)	Width (mm)
3 381 70	2000	600
3 381 71	2000	800
3 381 72	2200	600
3 381 73	2200	800

There is an intermediate plate catalogue number (to cut if needed to 2000 mm height) : Cat.No 3 381 74.

### Mounting plain plates :

- Cut the two crosspieces if needed (if it is a 400 mm or 600 mm depth)

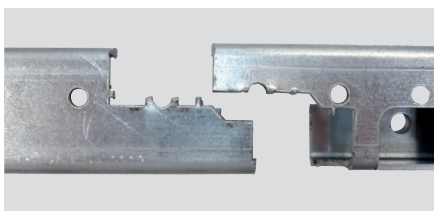
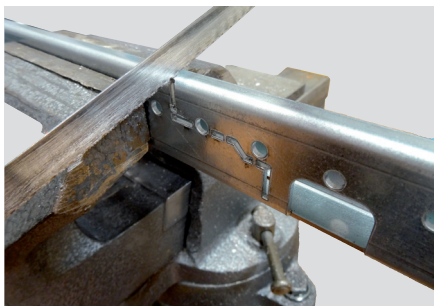

- Fix the crosspieces on the sides at the bottom of the enclosure using the screws provided (2 per crosspiece): Torx S30 end-piece, tightening torque 5 N.m.

Example of a 800 mm depth :



- Fix the 2 brackets on the upper part of the enclosure (left and right) using the screws provided (2 per brackets): Torx S30 end-piece, tightening torque 5 N.m.

Example of the upper right bracket :



- Insert the clip-nuts in the 4 metallic supports.

-  The hole is rectangle-shaped, check to well positioned the clip-nut "ears" in the narrow part to ensure a good holding.



- Fix the 2 supports in the brackets previously installed, then the other 2 supports in the lower crosspieces: Torx S30 end-piece, tightening torque 5 N.m.

-  There are two different brackets :

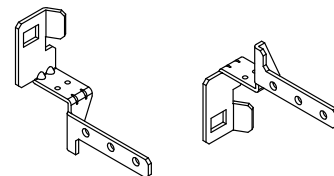

Fixation of a support in a bracket :





Fixing a crosspiece :



- Fix on the top the retraining clips (left and right): Torx S30 end-piece, tightening torque 5 N.m.



- Put in place 2 black plastic trims at the bottom of the plain plate (left and right) using a soft hammer.

Bottom right corner :

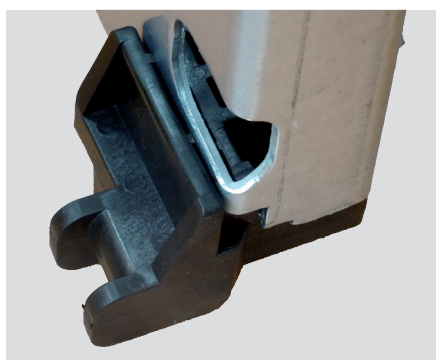

- Position the plain plate and push it until it is retained by the retaining clips

- Fix the plain plate using the 4 screws provided: 6 mm Allen key, tightening torque 8 N.m.

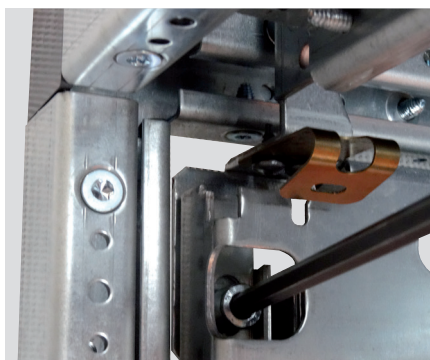

- i** It is possible to install a plain plate in an intermediate position in depth. Make sure to use the largest holes for fixing elements :



Graduations are engraved on the plain plate to ease the alignment and implementation of products. The space between 2 little lines represent 1 cm and between 2 big lines it is 10 cm.



#### Mounting an intermediate plate (Cat.No 3 381 74) :

When joining one or several enclosures equipped with a plain plate, the installation of an intermediate plate enable the surface and cabling continuity as well as the installation of products.

There is one catalogue number corresponding to a 2200 mm height, but you can cut it where it is indicated to obtain a 2000 mm height.

Example of the pre-cut :

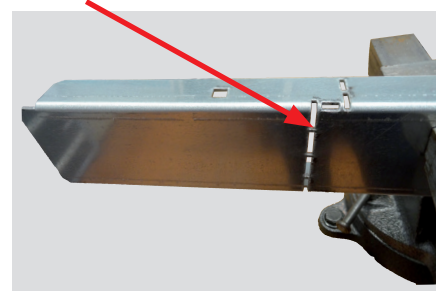



# MOUNTING DEVICES

It is required to locate on the plate the future position of the clip-nuts provided. After having installed the plain plates and joined the enclosures, place at the back the intermediate plate between the enclosures and identify the square-shaped holes which must be in front of the plain plates' holes.

Square-shaped holes identification :



After having identified the 2 sides of the intermediate plate, position the clip-nuts on the inside :



Juxtapose the intermediate plate next to the plain plates :

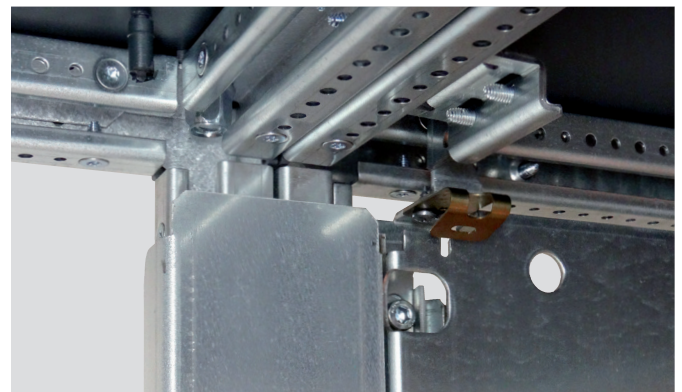

Fix the intermediate plate at the rear of the enclosure using the screws provided via the holes of the plain plates: 10 mm hexagonal head, tightening torque 5 N.m.



### 3 MOUNTING SPX/SPX-D/SPX<sup>3</sup>-V

#### ■ SPX :

Before mounting, identify the needs :

- 2 possibilities: mounting using a plate or busbars
- Vertical or horizontal mounting
- Width of the enclosure: 16, 24 or 36 modules
- Rated current

125 A	SPX 000
160 A	SPX 00
250 A	SPX 1
400 A	SPX 2
630 A	SPX 3

**!** Products mounted on a plate will only be in a vertical position. The SPX-3 does not suit for a 16 modules enclosure. SPX 000/00/1 mounted on busbars will only be in a vertical position.

**Maximum number of products on a single plate depending on the configuration :**

	16 mod.	24 mod.	36 mod.
SPX 000	3	4	7
SPX 00	2	4	6
SPX 1	1	2	2
SPX 2	1	1	2
SPX 3	0	1	1

#### How to position a SPX product range on a plate? :

- Bend the plate's brackets using a flat pliers
- Fix the product on the plate using screws, tightening torque 2 N.m.
- Fix the plate on the functional uprights using 2 screws, Torx S30 end-piece, tightening torque 8 N.m.

Putting in a place the SPX range on busbar is carried out as follow:

#### How to position a SPX product range on busbars? :

- Mandatory equipment for vertical mounting:
  - Crosspieces Cat.No 3 379 80 (16 modules) or 3 337 81 (24 modules) or 3 337 82 (36 modules).
  - Fixing bracket Cat.No 3 392 50
  - Isolating support Cat.No 6 052 46

- Install your 2 crosspieces on the functional uprights
- Fix the rear part of the isolating supports on the brackets metallic supports: 2 screws per support, tightening torque 4 N.m.
- Fix your 2 brackets in the middle of the 2 crosspieces (see markers on the crosspieces): 2 screws per bracket, tightening torque 8 N.m.

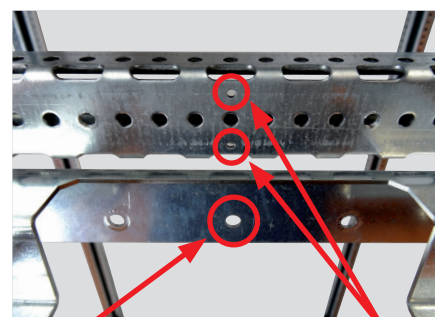

Representing the middle of the bracket

Marks representing the middle of the width

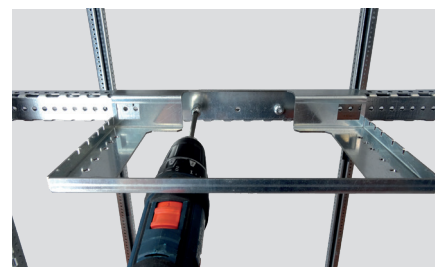

- Fix the brackets metallic supports (with the isolating supports) on the brackets respecting the position.

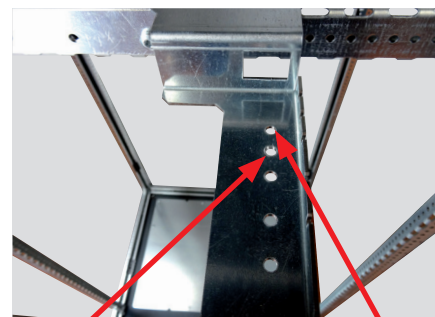

Fixing holes for SPX 2

Fixing holes for SPX 3

# MOUNTING DEVICES

- Position the bars in the rear part of the isolating supports .
- Fix the rear part of the isolating supports on the front parts: 4 screws per support, tightening torque 4 N.m.

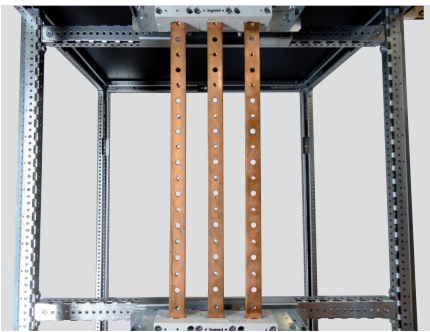

- Put in place the SPX (below find an example with a SPX-2).

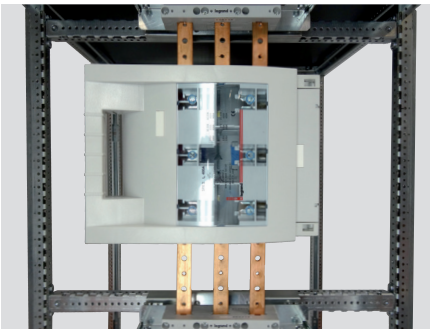

## • Mandatory equipment for horizontal mounting :

- Fixing brackets Cat.No 3 392 50
- Isolating supports Cat.No 6 052 46
- Fix the rear part of the isolating supports on the front parts: 4 screws per support, tightening torque 4 N.m.
- Bend the plate's brackets using a flat pliers .

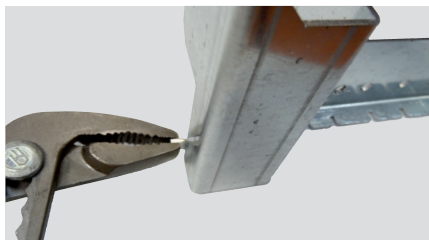

- Fix the brackets on the functional uprights: 1 screw per bracket, Torx S30 end-piece, tightening torque 8 N.m.



- Fix the brackets metallic supports (with the isolating supports) on the brackets respecting the position.

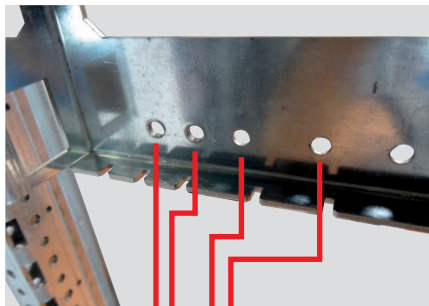

- SPX 000/00
- SPX 1
- SPX 2
- SPX 3

- Position the bars in the rear part of the isolating supports.
- Fix the rear parts of the isolating supports on the front parts: 4 screws per support, tightening torque 4 N.m.



- Put in place SPX (below an example with a SPX 00).



- ! Distance to respect between the isolating support on the left and the product to install the faceplate :

- SPX 000 : 41,5 mm
- SPX 00 : 8 mm
- SPX 1 : 37,5 mm
- SPX 2 : 118 mm
- SPX 3 : 95 mm



### ■ SPX-D

**!** The products mounted on the plate must be in a vertical position. Only the SPX-D 160 can be mounted in a 16 modules enclosure. There is only one case where 2 products can be mounted on the same plate: 2 x SPX-D 160 in a 36 modules enclosure.

	Height of the faceplate (mm)
SPX-D 160	300
SPX-D 250/400/630	450

How to position a SPX product range on a plate? :

- Bend the plate's brackets with a flat pliers
- Install 4 clip-nuts in the plate\*
- Fix the product on the plate using the screws provided, tightening torque 2 N.m\*.
- Fix the plate on the functional uprights using 2 screws: Torx S30 end-piece, tightening torque 8 N.m.

\*Not for SPX-D 250/400/630, use the screws directly on in the plate to fix the products, tightening torque 2 N.m.

### ■ SPX<sup>3</sup>-V

**!** Products can be in a vertical position (24 or 36 modules enclosure) or horizontal (only for a 36 modules).

Same mounting for any catalogue number (as a reminder, 4 catalogue numbers are available) :

- 6 058 50 : SPX<sup>3</sup>-V 160A
- 6 058 51 : SPX<sup>3</sup>-V 250A
- 6 058 52 : SPX<sup>3</sup>-V 400A
- 6 058 53 : SPX<sup>3</sup>-V 630A

Mandatory products for mounting in a **vertical** position :

- 3 394 40/41 : 2 fixing brackets for isolating supports, faceplate included
- 6 058 80 : 4 isolating supports

Mandatory products for mounting in a **horizontal** position :

- 3 394 51 : 1 fixing crosspiece with 1 isolating support

**Example of a SX<sup>3</sup>-V 160A mounting in a vertical position :**

Cat.No 3 394 40/41 :



Cat.No 6 058 80 :



- Fix the 2 brackets on the functional uprights using the screws provided respecting the installation direction: Torx S30 end-piece, tightening torque 8 N.m.

Example of a right bracket :



- Remove the front part of the isolating support on the brackets unscrewing 4 screws:



# MOUNTING DEVICES

- Fix the rear part of the isolating support on the brackets: 4 screws per support + 4 nuts (both are not provided). You need to use :

- Ø 8 mm screws
- Length: 40 mm
- Allen 6 mm
- Nuts for M8 screws

Make sure to always use the right holes in the brackets depending on the bar's width (thickness 10 mm):

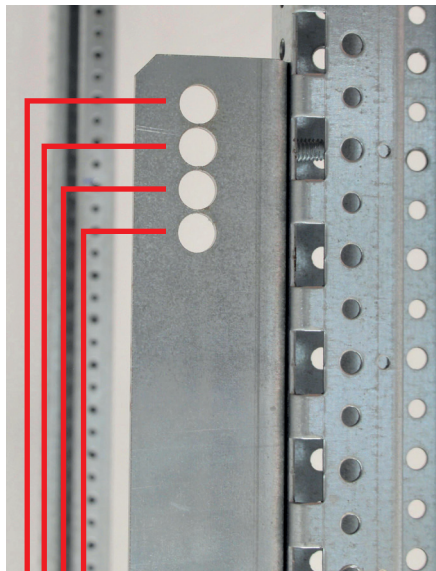

- Bar's height = 60 mm
- Bar's height = 80 mm
- Bar's height = 100 mm
- Bar's height = 120 mm

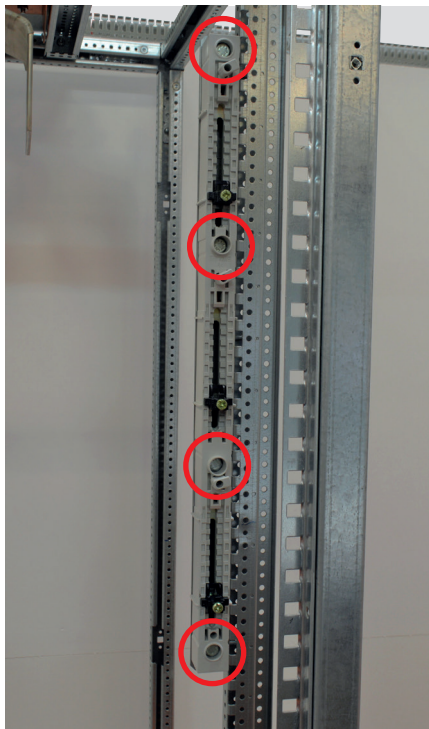

- Unscrew 3 turns the adjusting screw (for the bar's width) .

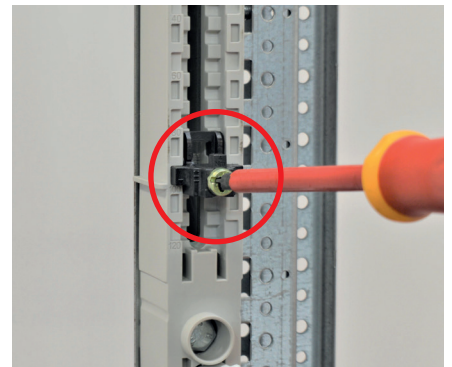

- Pull the black latch back towards you, adjust the width respecting the instructions written on the support then re-tighten the screws: Pozidriv n°3, tightening torque 4 N.m. Repeat the operation for all the other black latches.

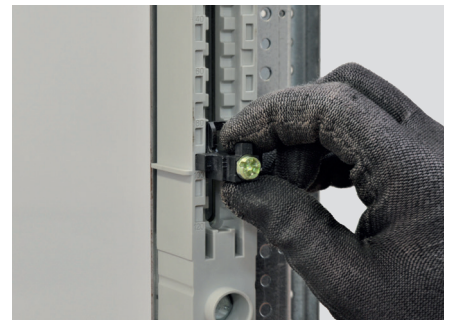

- Turn 90° all the latches.



- Position the 1st bar and close the latches. Repeat the operation for the other bars.
- Fix again all the front part of the isolating supports: Pozidriv n°3, tightening torque 4 N.m.



- Take a SPX<sup>3</sup>-V product, open with the handle then tilt the plastic deco head to clear the holes dedicated to fixing screws.

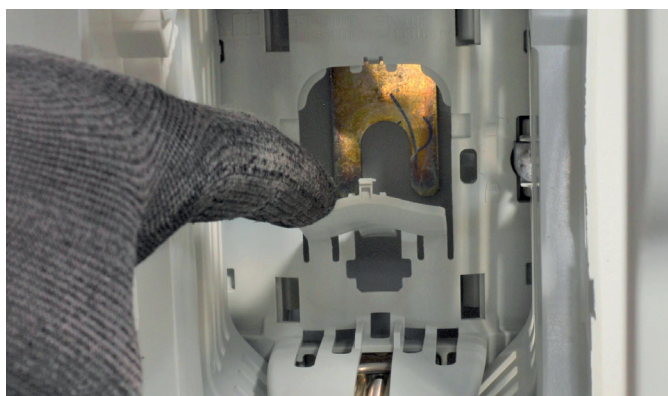

- Position the products on bars then fix: 4 screws per support + 4 washers + 4 nuts (**screws, washers and nuts are not provided**). You need to use :

- Ø 8 mm screws
- Length : 25 mm
- Allen 6 mm
- Washers for M8 screws
- Nuts M8 screws



- Close all the plastic deco head.
- The product is now in place





# MOUNTING DEVICES

## 4 MOUNTING DMX<sup>3</sup>

**i** The catalogue numbers regarding plates are the same for a withdrawable or fixed mounting DMX<sup>3</sup> (3 or 4 poles). The catalogue numbers are different in relation to the enclosure's width and the DMX<sup>3</sup> type (1600, 2500 or 4000).

Mounting possibilities and catalogue numbers of the required devices :

	DMX <sup>3</sup> 1600	DMX <sup>3</sup> 2500	DMX-SP 2500	DMX <sup>3</sup> 4000/ DMX SP 4000
Plate for a 16 modules enclosure + crosspieces	3 391 01 + 3 397 34 (depth. 400 mm) 3 397 35 (depth. 600 mm) 3 397 36 (depth. 800 mm)	-	-	-
Plate for a 24 modules enclosure + crosspieces	3 391 03 + 3 397 34 (depth. 400 mm) 3 397 35 (depth. 600 mm) 3 397 36 (depth. 800 mm)	3 391 43 + 3 397 34 (depth. 400 mm) 3 397 35 (depth. 600 mm) 3 397 36 (depth. 800 mm)	3 392 22	-
Plate for a 36 modules enclosure + crosspieces	3 391 05 + 3 397 34 (depth. 400 mm) 3 397 35 (depth. 600 mm) 3 397 36 (depth. 800 mm)	3 391 45 + 3 397 34 (depth. 400 mm) 3 397 35 (depth. 600 mm) 3 397 36 (depth. 800 mm)	3 392 25	3 391 85 + 3 397 34 (depth. 400 mm) 3 397 35 (depth. 600 mm) 3 397 36 (depth. 800 mm)
Min. free space for faceplate at the top of the enclosure	200 mm	300 mm	300 mm	300 mm
Min. distance top of the enclosure / crosspiece's fixing screw	650 mm	800 mm	800 mm	800 mm

### ■ Mounting :

- Use two crosspieces corresponding to the enclosure's depth (the Cat.no includes 2 crosspieces, 2 fixing lugs and 12 self-tapping screws).
- Fix the fixing lugs respecting the mini distance regarding the top of the enclosure (see table): Torx S.30 end-piece, tightening torque 5 N.m.



-Fix the crosspieces on the fixing brackets (2 screws/bracket): Torx S30 end-piece, tightening torque 5 N.m.



- Then, fix the plate on the crosspieces (2 screws/crosspiece): Torx S30 end-piece, tightening torque 5 N.m. Use the 2nd hole of the crosspiece, starting from the edge (front of the enclosure).



Fix in the 2nd hole

- Fixing the DMX<sup>3</sup> on the plate :  
Use the screws and washers that were on the pallet and fix the DMX<sup>3</sup> (tightening torque 10 N.m.) respecting the holes explained on the diagram :

**DMX<sup>3</sup> 1600: round holes**

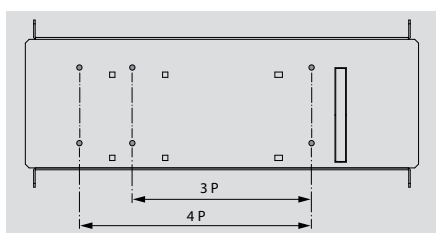

**DMX<sup>3</sup> 1600 withdrawable: square holes**

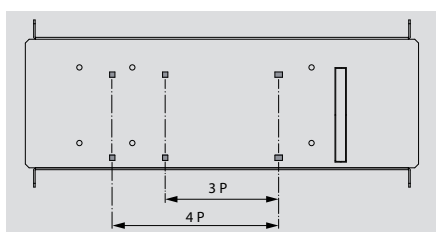

**DMX SP 2500 fixed: square holes**

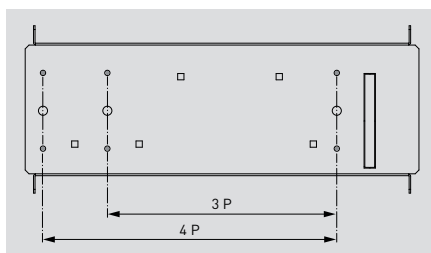

**DMX SP 2500 withdrawable: square holes**

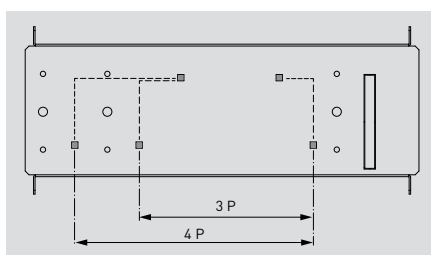

**DMX<sup>3</sup> 2500/4000/DMX SP 4000 fixed: round holes**

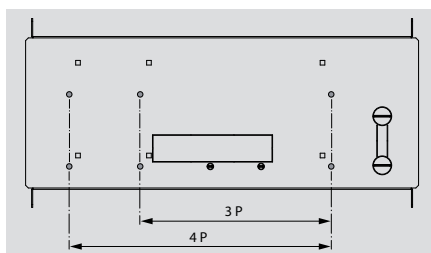

**DMX<sup>3</sup> 2500/4000/DMX SP 4000 withdrawable: square holes**

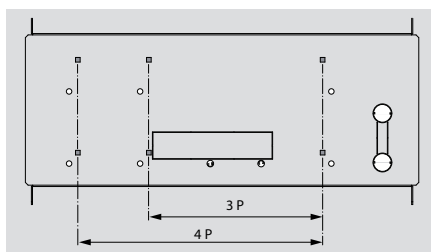

Example of a DMX<sup>3</sup> 1600 :

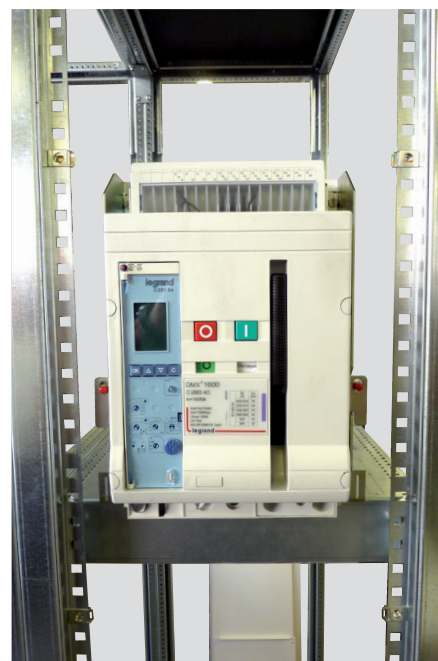

# CABLING AND JUNCTION

**!** When mounting inside the enclosure, make sure to always use the largest holes (Ø 5.4 mm) to fix the equipment. The smallest holes (Ø 4.6 mm) are used to insert anti-rotation studs.

## 1 WIRING GUIDE FOR ALUMINUM RAIL (CAT.NO 4 052 25)

Fixing the horizontal wiring guide will be done promptly and without using tools. You only need to clip behind the rails Cat.No 3 382 20, 3 382 23, and 3 382 26.

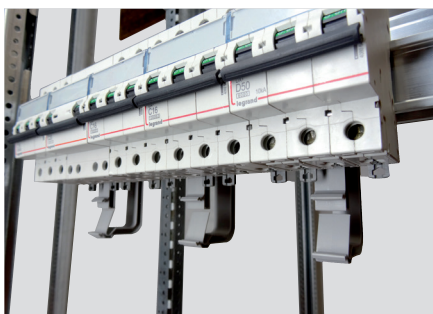

## 2 LINA 25 DUCT

■ You can associate Lina 25 duct with a rail to cut (thickness 15 mm Cat.No 0 477 23).

• First, you need to cut the rail at the desired length: :

Enclosure 16 M	Enclosure 24 M	Enclosure 36 M
370 mm	520 mm	720 mm

• Fix the rail on the functional uprights with 2 self-tapping screws → Torx S.30, tightening torque 8 N.m.

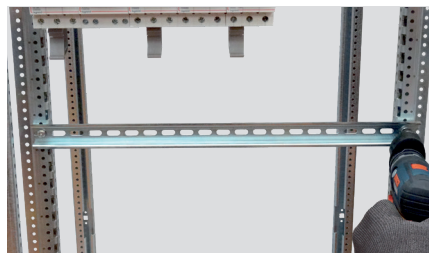

• Clip at least 2 Linatix accessories on the rail (Cat.No 0 366 40).

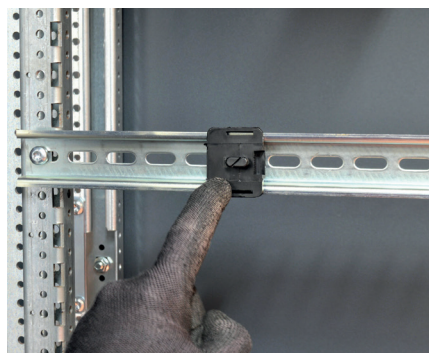

• Cut the Lina duct at the desired length while considering the possible use of the vertical duct.

• Drag the accessories to enable the locking in the duct's holes. Push the duct at the maximum to the rail then turn a quarter turn the accessory with a flat screw-driver (4 mm) to fix the whole.

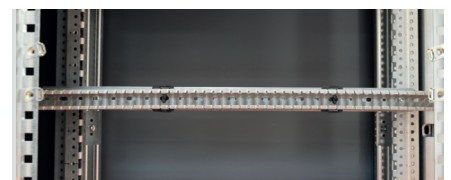
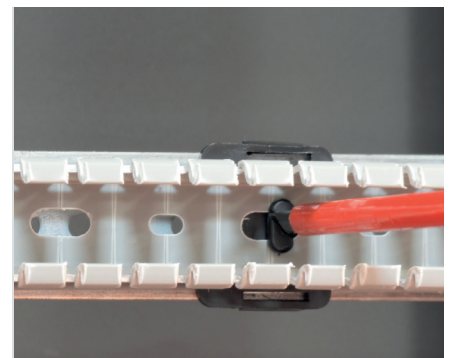

- It is possible to fix the duct on the rear uprights using insulating rivets (Cat.No 0 200 80).



Use the largest holes on the uprights .  
2 ducts mounting (horizontal and vertical) :

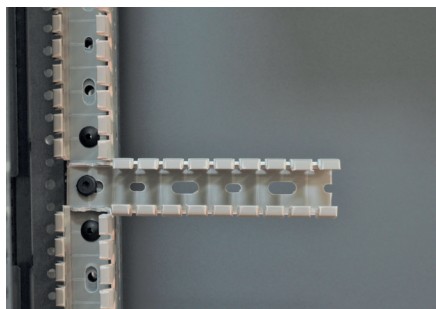

- You can associate Lina 25 duct with fixing lugs Cat.No 3 397 58.

Composition :



- Bend the lugs where needed, depending on the ducts depth (see the instructions).

Bending example :



- Fix the 2 lugs on the functional uprights using S. 30 Torx screws provided (1 screw per lug, tightening torque 5 N.m.)



- Position the angles on the lugs according to the ducts depth (see the table in the instruction sheets) and then fix using M6 screws + nuts (1 screw per lug, tightening torque 5 N.m.)

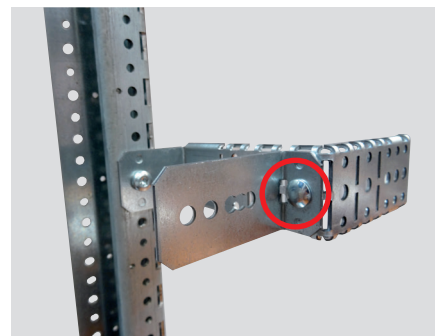

- After having cut the ducts at the desired length, fix them on the lugs using the plastic rivets provided (if you need more rivets, the Cat.No is 0 366 46).

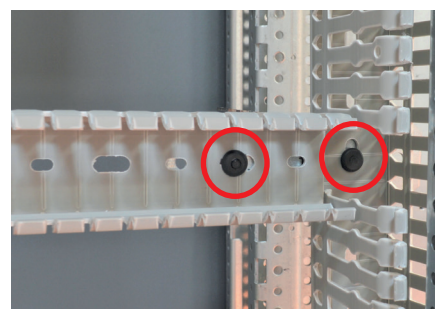



## 3 TERMINAL BLOCKS

It is possible to install a rail on the functional uprights and install Viking terminal blocks. You need to determine which rail is adapted to your needs (length: 2 meters to cut) :

Cat.No	Depth (mm)
0 374 07	15
0 477 23	15 with oblongs
0 374 04	7,5
0 477 22	7,5 with oblongs

The universal inclined or not inclined supports Cat.No 3 397 51 can also be a solution depending on the configuration of the enclosure.

Composition :

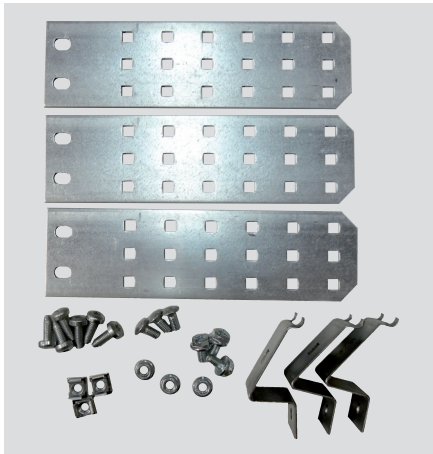

- Insert the 3 clip-nuts in the lugs



- Then insert the fixing lugs in the metallic supports using M6 screws + the washers provided (1 screw per lug, tightening torque 5 N.m.)



- Fix the metallic supports on the functional uprights using S.30 Torx screws (2 screws per support, tightening torque 5 N.m.)

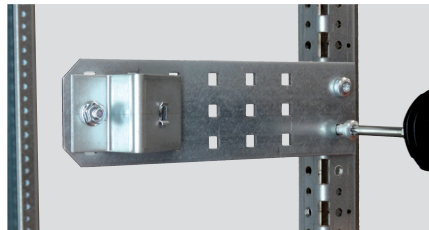

- Fix the rail (after cut if needed, Cat.nos to choose in the table) using hexagon head M6 screws provided (1 screw per lug, tightening torque 5 N.m.)



It is possible to install a Lina 25 duct as a complementary option to enable the cable passage. Use the plastic screws Cat.No 0 367 74 with nuts for M6 screws.

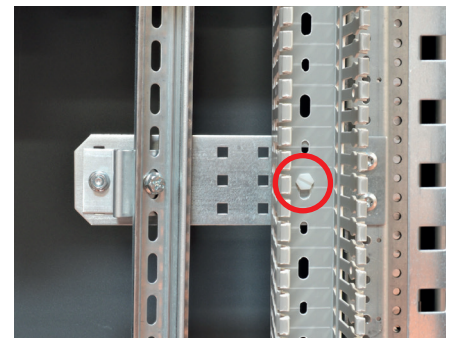

The rail can also be inclined or not. Do not install the lugs on the supports but directly fix on the lugs on the rails using M6 screws + the nuts provided (1 screw per lug, tightening torque 5 N.m.)

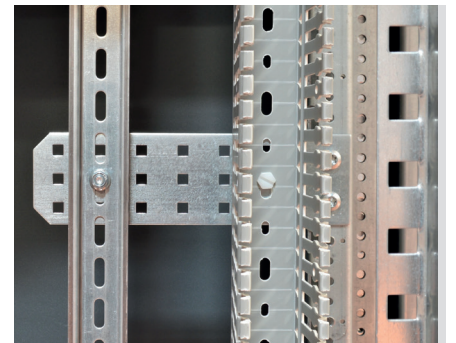

 Viking terminal blocks can also be installed on a rail mounted on supports Cat.No 3 397 21.

#### 4 CABLE FIXING (WIRE MESH CABLE TRAYS)

The latter can be vertically installed inside external cable sleeves. You need to use a wire mesh and a crosspiece.

##### Enclosure width

Ext. cable sleeve	16 modules
<b>Crosspieces Cat.No</b>	
3 397 30 (bottom of the enclosure)	3 397 31 (bottom of the enclosure)
3 397 34 (depth. 400 mm)	3 397 34 (depth. 400 mm)
3 397 35 (depth. 600 mm)	3 397 35 (depth. 600 mm)
3 397 36 (depth. 800 mm)	3 397 36 (depth. 800 mm)
<b>U cable trays Cat.No</b>	
0 464 69	0 464 69 or 0 464 70

##### Dimensions of the 2 Cat.No U cable trays

	Cat.No 0 464 69	Cat.No 0 464 70
Length	3000 mm	3000 mm
Width (overall)	218 mm	424 mm
Width (interior)	200 mm	400 mm
Depth (overall)	64 mm	64 mm
Depth (interior)	54 mm	54 mm

Once you determined the Cat.Nos needed (cable trays and crosspiece), you need to :

- Fix the crosspieces lugs on the structure's uprights using S.30 Torx screws provided (1 screw per lug, tightening torque 8 N.m.)

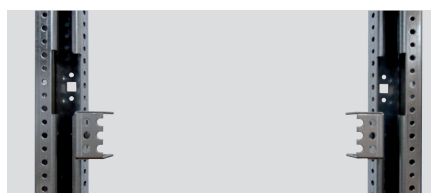
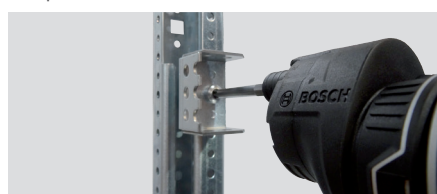

- Fix the crosspieces on these lugs using S30 Torx screws provided (2 screws per lug, tightening torque 8 N.m.)

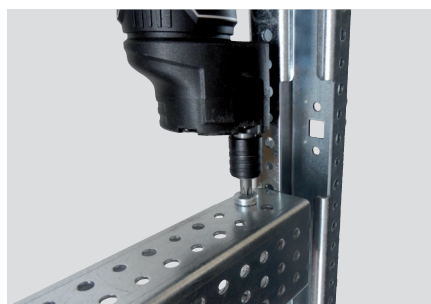

- Cut the tray at the desired length .
- Use the U parts provided with the tray to fix the latter on the crosspieces. Use S.30 Torx auto-tapping screws, tighten until the middle of the U part stops on the crosspiece, it means the tray is blocked. Use 2 U parts per cross-piece.

U parts :

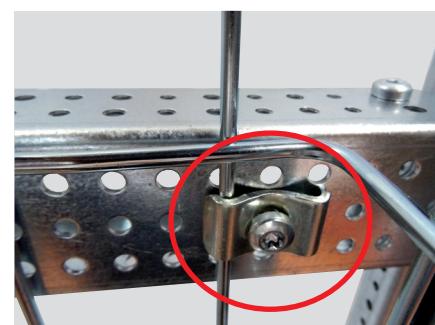

Fixing cables on the tray is possible when using Colson cable ties (adapted length and width).



# CABLING AND JUNCTION

## 5 CABLE PASSAGE BETWEEN THE DOOR AND THE ENCLOSURE

You can use :

- Lina 25 braided sleeving :  
0 366 38 → Ø 20 mm, length 50 m  
0 366 39 → Ø 30 mm, length 50 m.

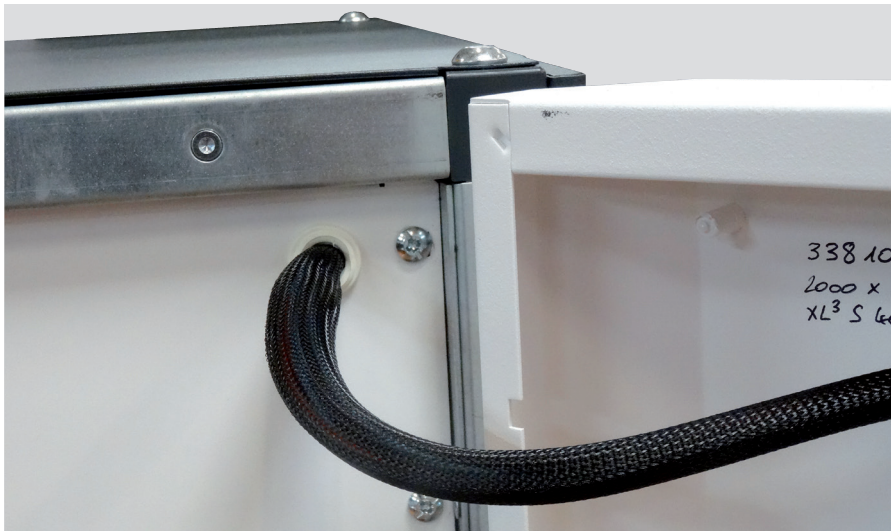

- Spiral sleeving :  
6 361 78 → Ø 12 mm  
6 361 83 → Ø 22 mm.

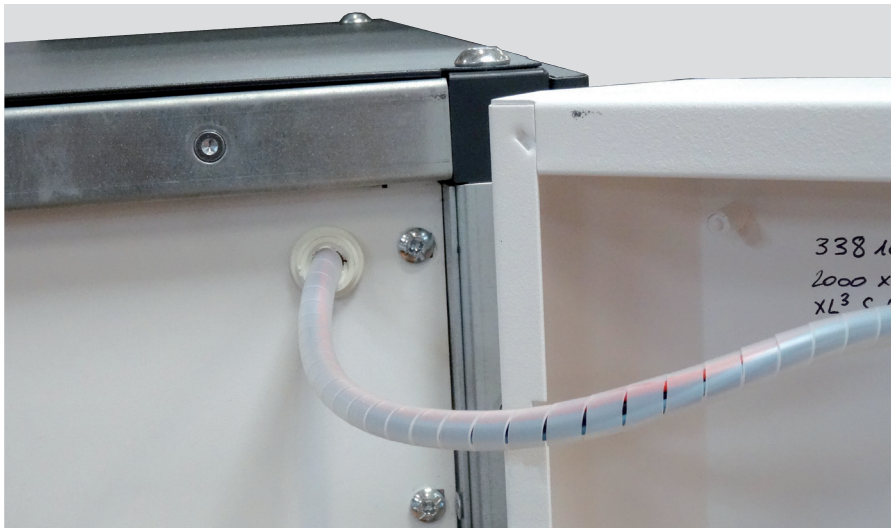

The cabling passage inside the door can be made using these references associated with self-adhesive bases:  
Cat.No 0 320 65 (colorless), 0 320 67 (black) or 0 320 68 (black for large rings).

Example Cat.  
No 0 320 67 :



## 6 CABLE ENTRY

Entries can be released using plates delivered with the enclosures (equipped with cable glands).

■ **Cat.No 0 329 46: IP 43 cable entry plate with brush**

Dimensions : 385 mm x 30 mm

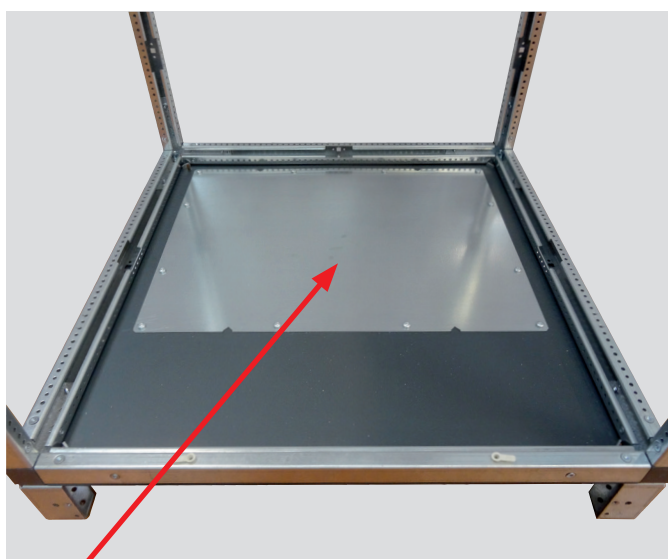
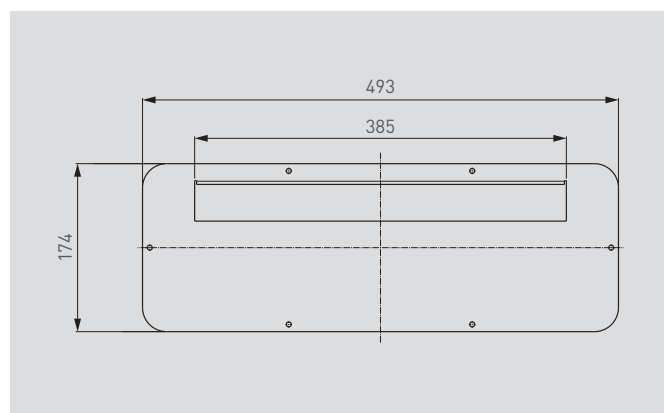



Plate to enable the cable passage



 It is also possible to cut (roof or movable plate of the base) and fix the VID cable entry plates with brush or with cable glands Cat.No 0 329 46.

## 7 TREATING PROTECTIVE CONDUCTORS

The main collector is used to link :

- The main protective conductor
- Circuits protective conductors
- Possibly the transformer's protective conductor
- Equipotential bondings

In XL<sup>3</sup> S 4000 enclosures, you can create this type of junction using the following solution (equipped with supports Cat.No 3 397 21) :

**Supports Cat.No 3 397 21 :**



Fix the supports on the functional uprights using 4 countersunk head screws provided.



- Terminal blocks (alone or IP 2X) mounted on a flat bar 12x2 mm Cat.No 0 048 19

Insert the flat bar(s) in the indicated spaces and clip the IP2X terminal blocks.

**!** 2 thickness regarding bars are possible in the supports: 2 and 4 mm.

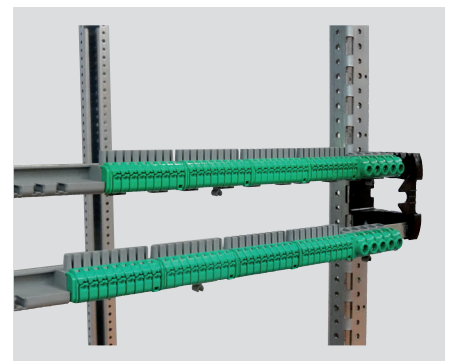
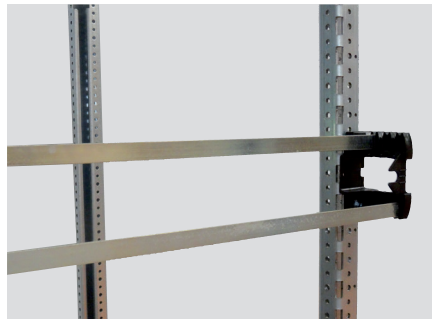

- Brass bar for 24 Modules Cat.No 0 373 01
- Brass bar for 36 Modules Cat.No 3 397 57
- Copper bar with tapped holes Cat.No 0 373 89

Same mounting as the flat bar (0 048 19) but respecting the spacing: 4 mm :

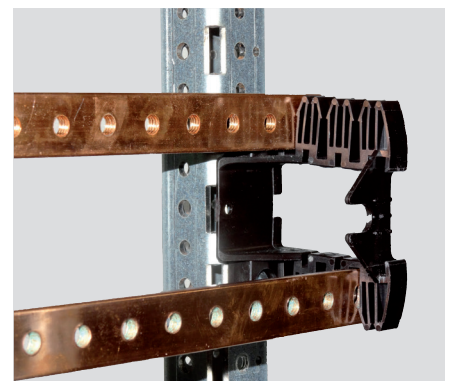

- Copper bar 12 x 4 mm  
Cat.No 0 373 49: same mounting  
0 373 897
- Copper bar with tapped holes  
0 374 34/38. Use the clips given :

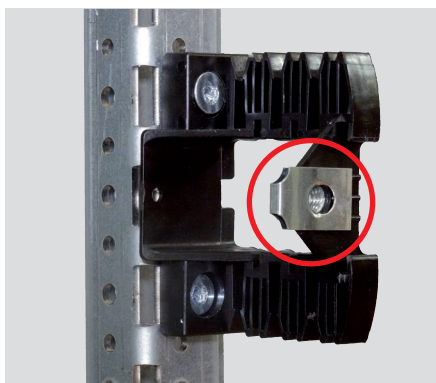

- Terminal blocks Viking mounted on a rail.
- Then 2 mountings are now possible :
- Using clips/screws on the supports' front face:
  - 0 374 04 : rail to cut – depth 7.5 mm
  - 0 477 22 : rail to cut with oblongs – depth 7.5 mm
  - 0 374 07 : rail to cut – depth 15 mm
  - 0 477 23 : rail to cut with oblongs – depth 15 mm

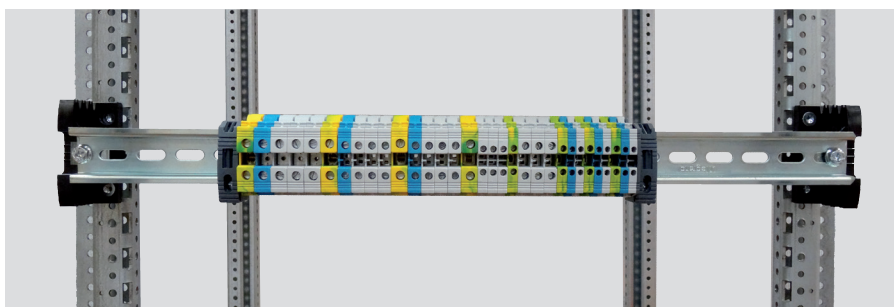

Only a 27 mm (width) bar is accepted.

Fix the bar using the 2 screws given with the supports.

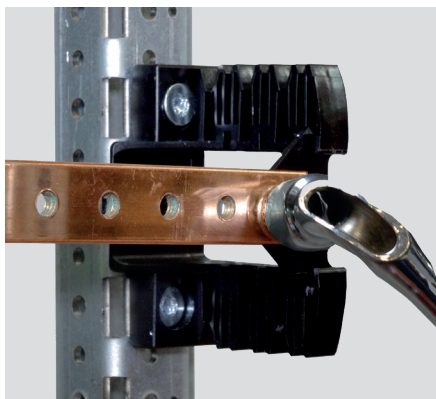

- Inserting at the bottom of the supports respecting these steps: fix a support, insert the rail where indicated, insert the rail in the 2nd indicated notches of the support and then fix your 2nd support. The compatible Cat. Nos are :

- 0 374 07 : rail to cut – depth 15 mm
- 0 477 23 : rail to cut with oblongs – depth 15 mm

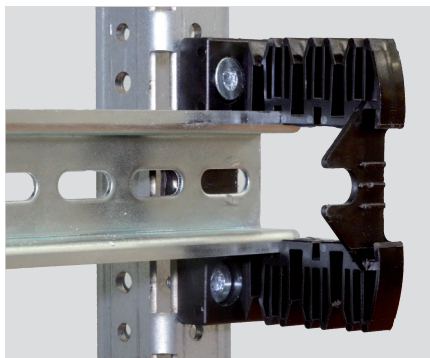



# DISTRIBUTION SYSTEM

The XL<sup>3</sup> S 4000 distribution system enables to create several combinations of aluminum and copper aligned, inclined or staggered busbars. Thanks to a

crosspiece system, installing busbars is now possible for each type of enclosure. Moreover, different positions are possible: at the bottom, sleeved, flat,

staggered, vertical, horizontal crossing several enclosures joined together.



Thanks to a universal crosspiece, the supports are adapted to each enclosure depth and width. Supports can be installed in a front position to have a front access regarding busbars behind the

plates, or at the back to a rear access. This innovative system increases safety, speed and the optimization of the enclosure's volume.



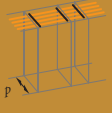
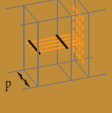
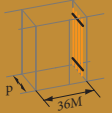

# DISTRIBUTION SYSTEM

In. Maxi (A)		Flat copper bars											
		IP ≤ 30	450	800	3600	4800							
		IP > 30	400	700	3000	4000							
Mounting		Supports		3 399 00		3 399 01		3 399 06		3 399 20/21/22/23 spacing 75 mm		3 399 29/30 spacing 125 mm	
	Main horizontal top or bottom	D : 400								3 399 20/23 + 3 399 36/37/38/39 <sup>(4)</sup>			
		D: 600	Front access <sup>(1)</sup>								3 399 21/23 + 3 399 36/37/38/39 <sup>(4)</sup>		
			Rear access <sup>(2)</sup>								3 399 21/23 + 3 399 36/37/38/39 ou 3 399 20/23 + 3 399 36/37/38/39 <sup>(5)</sup>		3 399 29/30
		D: 800	Front access <sup>(1)</sup>									3 399 22/23 + 3 399 36/37/38/39 <sup>(4)</sup>	
Rear access <sup>(2)</sup>										3 399 22/23 + 3 399 36/37/38/39 ou 3 399 21/23 + 3 399 36/37/38/39 <sup>(5)</sup>		3 399 29/30	
	Horizontal transfer	D: 400								3 399 20/23 + 3 399 36/37/38/39 <sup>(6)</sup>			
		D: 600	Front access <sup>(1)</sup>								3 399 21/23 + 3 399 36/37/38/39 <sup>(6)</sup>		
			Rear access <sup>(2)</sup>								3 399 21/23 + 3 399 36/37/38/39 <sup>(6)</sup> ou 3 399 20/23 + 3 399 36/37/38/39 <sup>(7)</sup>		3 399 29/30
		D: 800	Front access <sup>(1)</sup>									3 399 22/23 + 3 399 36/37/38/39 <sup>(6)</sup>	
Rear access <sup>(2)</sup>										3 399 22/23 + 3 399 36/37/38/39 <sup>(6)</sup> ou 3 399 21/23 + 3 399 36/37/38/39 <sup>(7)</sup>		3 399 29/30	
	Vertical lateral internal cable sleeve	D: 400		3 399 00 + 3 397 34						3 399 20/23 + 3 399 36/37/38/39 <sup>(3)</sup>			
		D: 600	Front access <sup>(1)</sup>	3 399 00 + 3 397 35				3 399 06 + 3 397 35			3 399 21/23 + 3 399 36/37/38/39		
			Rear access <sup>(2)</sup>	3 399 00 + 3 397 35				3 399 06 + 3 397 35			3 399 21/23 + 3 399 36/37/38/39		
		D: 800	Front access <sup>(1)</sup>	3 399 00 + 3 397 36				3 399 06 + 3 397 36				3 399 22/23 + 3 399 36/37/38/39	
Rear access <sup>(2)</sup>	3 399 00 + 3 397 36				3 399 06 + 3 397 36				3 399 22/23 + 3 399 36/37/38/39				

1: The main horizontal busbar is positioned at the front of the enclosure, vertical busbars are accessible at the front, behind the faceplates (mainly via cable sleeves)  
 2: The main horizontal busbar is positioned at the back of the enclosure and the vertical busbars are accessible at the back of the enclosure by removing the rear panels.  
 3: Junction only possible using a main horizontal busbar at the top or bottom - «C» aluminum bars.  
 4: Partial chassis

Aluminum bars						
700		1750			3500	
630		1600			3200	
<b>3 399 02/03</b>	<b>3 399 04/05</b>	<b>3 399 20 /21/22/23 spacing 75 mm</b>	<b>3 399 31/32/33 spacing 75 mm</b>	<b>3 399 25/26/27 spacing 125 mm</b>	<b>3 399 20 /21/22/23 spacing 75 mm</b>	<b>3 399 25/26/27 spacing 125 mm</b>
		3 399 20/23 + 3 399 40 <sup>(4)</sup>			3 399 20 + 3 399 23 + 3 399 24 <sup>(4)</sup>	
		3 399 21/23 + 3 399 40 <sup>(4)</sup>		3 399 25/27 + 3 399 40 <sup>(4)</sup>	3 399 21 + 3 399 23 + 3 399 24 <sup>(4)</sup>	3 399 25 + 3 399 27 + 3 399 24 <sup>(4)</sup>
		3 399 21/23 + 3 399 40 ou 3 399 20/23 + 3 399 40 <sup>(5)</sup>		3 399 25/27 + 3 399 40 <sup>(4)</sup>	3 399 21 + 3 399 23 + 3 399 24 ou 3 399 20 + 3 399 23 + 3 399 24 <sup>(5)</sup>	3 399 25 + 3 399 27 + 3 399 24 <sup>(4)</sup>
		3 399 22/23 + 3 399 40 <sup>(4)</sup>		3 399 26/27 + 3 399 40 <sup>(4)</sup>	3 399 22 + 3 399 23 + 3 399 24 <sup>(4)</sup>	3 399 26 + 3 399 27 + 3 399 24 <sup>(4)</sup>
		3 399 22/23 + 3 399 40 ou 3 399 21/23 + 3 399 40 <sup>(5)</sup>		3 399 26/27 + 3 399 40 ou 3 399 25/27 + 3 399 40 <sup>(5)</sup>	3 399 22 + 3 399 23 + 3 399 24 ou 3 399 21 + 3 399 23 + 3 399 24 <sup>(5)</sup>	3 399 26 + 3 399 27 + 3 399 24 ou 3 399 25 + 3 399 27 + 3 399 24 <sup>(5)</sup>
		3 399 20/23 + 3 399 40 <sup>(6)</sup>			3 399 20 + 3 399 23 + 3 399 24 <sup>(6)</sup>	
		3 399 21/23 + 3 399 40 <sup>(6)</sup>		3 399 25/27 + 3 399 40 <sup>(6)</sup>	3 399 21 + 3 399 23 + 3 399 24 <sup>(6)</sup>	3 399 25 + 3 399 27 + 3 399 24 <sup>(4)</sup>
		3 399 21/23 + 3 399 40 <sup>(6)</sup> ou 3 399 20/23 + 3 399 40 <sup>(7)</sup>		3 399 25/27 + 3 399 40 <sup>(6)</sup>	3 399 21 + 3 399 23 + 3 399 24 <sup>(6)</sup> ou 3 399 20 + 3 399 23 + 3 399 24 <sup>(7)</sup>	3 399 25 + 3 399 27 + 3 399 24 <sup>(6)</sup>
		3 399 22/23 + 3 399 40 <sup>(6)</sup>		3 399 26/27 + 3 399 40 <sup>(6)</sup>	3 399 22 + 3 399 23 + 3 399 24 <sup>(6)</sup>	3 399 26 + 3 399 27 + 3 399 24 <sup>(6)</sup>
		3 399 22/23 + 3 399 40 <sup>(6)</sup> ou 3 399 21/23 + 3 399 40 <sup>(7)</sup>		3 399 26/27 + 3 399 40 <sup>(6)</sup> ou 3 399 25/27 + 3 399 40 <sup>(7)</sup>	3 399 22 + 3 399 23 + 3 399 24 <sup>(6)</sup> ou 3 399 21 + 3 399 23 + 3 399 24 <sup>(7)</sup>	3 399 26 + 3 399 27 + 3 399 24 <sup>(6)</sup> ou 3 399 25 + 3 399 27 + 3 399 24 <sup>(7)</sup>
3 399 02/03 + 3 397 34		3 399 20/23 + 3 399 40 <sup>(3)</sup>				
3 399 02/03 + 3 397 35		3 399 21/23 + 3 399 40		3 399 25/27 + 3 399 40		
3 399 02/03 + 3 397 35		3 399 21/23 + 3 399 40		3 399 25/27 + 3 399 40		
3 399 02/03 + 3 397 36		3 399 22/23 + 3 399 40		3 399 26/27 + 3 399 40		
3 399 02/03 + 3 397 36		3 399 22/23 + 3 399 40		3 399 26/27 + 3 399 40		

5: Mounting behind the central upright crosspiece



6: Enclosure equipped with crosspieces

7: Mounting behind the functional uprights

8: Except for a 400 mm depth

9: The two busbars are placed one above the other in the enclosure

# DISTRIBUTION SYSTEM

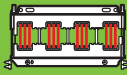
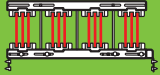
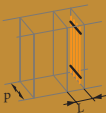
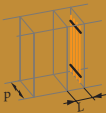
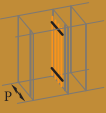
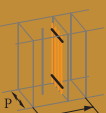



In. Maxi (A)		Flat copper bars					
		IP ≤ 30	450	800	3600	4800	
		IP > 30	400	700	3000	4000	
Mounting		Supports					
			3 399 00	3 399 01	3 399 06	3 399 20/21/22/23 spacing 75 mm	3 399 29/30 spacing 125 mm
	D : 400		3 399 00 + 3 397 34			3 399 20/23 + 3 399 36/37/38/39 <sup>(3)</sup>	
		D : 600	Front access <sup>(1)</sup>	3 399 00 + 3 397 35		3 399 06 + 3 397 35	3 399 21/23 + 3 399 36/37/38/39
	D : 800		Rear access <sup>(2)</sup>	3 399 00 + 3 397 35		3 399 06 + 3 397 35	3 399 21/23 + 3 399 36/37/38/39
			Front access <sup>(1)</sup>	3 399 00 + 3 397 36		3 399 06 + 3 397 36	3 399 22/23 + 3 399 36/37/38/39
	D : 400		3 399 00 + 3 397 34			3 399 20/23 + 3 399 36/37/38/39 <sup>(3)</sup>	
		D : 600	Front access <sup>(1)</sup>	3 399 00 + 3 397 35		3 399 06 + 3 397 35	3 399 21/23 + 3 399 36/37/38/39
	D : 800		Rear access <sup>(2)</sup>	3 399 00 + 3 397 35		3 399 06 + 3 397 35	3 399 21/23 + 3 399 36/37/38/39
			Front access <sup>(1)</sup>	3 399 00 + 3 397 36		3 399 06 + 3 397 36	3 399 22/23 + 3 399 36/37/38/39
	D : 600					3 399 20/23 + 3 399 36/37/38/39	
	D : 800				3 399 06 + 3 397 35	3 399 21/23 + 3 399 36/37/38/39	
	D : 600				3 399 06 + 3 397 35		
	D : 800				3 399 06 + 3 397 36		

1: The main horizontal busbar is positioned at the front of the enclosure, vertical busbars are accessible at the front, behind the faceplates (mainly via cable sleeves)  
 2: The main horizontal busbar is positioned at the back of the enclosure and the vertical busbars are accessible at the back of the enclosure by removing the rear panels.  
 3: Junction only possible using a main horizontal busbar at the top or bottom - «C» aluminum bars.  
 4: Partial chassis

Aluminum bars						
700		1750			3500	
630		1600			3200	
<b>3 399 02/03</b>	<b>3 399 04/05</b>	<b>3 399 20 /21/22/23 spacing 75 mm</b>	<b>3 399 31/32/33 spacing 75 mm</b>	<b>3 399 25/26/27 spacing 125 mm</b>	<b>3 399 20 /21/22/23 spacing 75 mm</b>	<b>3 399 25/26/27 spacing 125 mm</b>
3 399 02/03 + 3 397 34		3 399 20/23 + 3 399 40 <sup>(3)</sup>	3 399 31 <sup>(3)</sup>			
3 399 02/03 + 3 397 35		3 399 21/23 + 3 399 40	3 399 32	3 399 25/27 + 3 399 40	3 399 21 + 3 399 23 + 3 399 24	3 399 25 + 3 399 27 + 3 399 24
3 399 02/03 + 3 397 35		3 399 21/23 + 3 399 40	3 399 32	3 399 25/27 + 3 399 40	3 399 21 + 3 399 23 + 3 399 24	3 399 25 + 3 399 27 + 3 399 24
3 399 02/03 + 3 397 36		3 399 22/23 + 3 399 40	3 399 33	3 399 26/27 + 3 399 40	3 399 22 + 3 399 23 + 3 399 24	3 399 26 + 3 399 27 + 3 399 24
3 399 02/03 + 3 397 36		3 399 22/23 + 3 399 40	3 399 33	3 399 26/27 + 3 399 40	3 399 22 + 3 399 23 + 3 399 24	3 399 26 + 3 399 27 + 3 399 24
3 399 02/03 + 3 397 34		3 399 20/23 + 3 399 40 <sup>(3)</sup>	3 399 31 <sup>(3)</sup>			
3 399 02/03 + 3 397 35		3 399 21/23 + 3 399 40	3 399 32	3 399 25/27 + 3 399 40	3 399 21 + 3 399 23 + 3 399 24	3 399 25 + 3 399 27 + 3 399 24
3 399 02/03 + 3 397 35		3 399 21/23 + 3 399 40	3 399 32	3 399 25/27 + 3 399 40	3 399 21 + 3 399 23 + 3 399 24	3 399 25 + 3 399 27 + 3 399 24
3 399 02/03 + 3 397 36		3 399 22/23 + 3 399 40	3 399 33	3 399 26/27 + 3 399 40	3 399 22 + 3 399 23 + 3 399 24	3 399 26 + 3 399 27 + 3 399 24
3 399 02/03 + 3 397 36		3 399 22/23 + 3 399 40	3 399 33	3 399 26/27 + 3 399 40	3 399 22 + 3 399 23 + 3 399 24	3 399 26 + 3 399 27 + 3 399 24
3 399 02/03 + 3 397 34		3 399 20/23 + 3 399 40 <sup>(3)</sup>				
3 399 02/03 + 3 397 35		3 399 21/23 + 3 399 40		3 399 25/27 + 3 399 40		

5: Mounting behind the central upright crosspiece  
6: Enclosure equipped with crosspieces  
7: Mounting behind the functional uprights  
8: Except for a 400 mm depth  
9: The two busbars are placed one above the other in the enclosure

# DISTRIBUTION SYSTEM

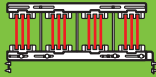
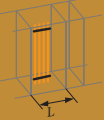
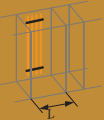
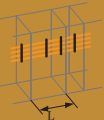
In. Maxi (A)		Flat copper bars					
		IP ≤ 30	450	800	3600	4800	
		IP > 30	400	700	3000	4000	
Mounting		Supports					
			3 399 00	3 399 01	3 399 06	3 399 20/21/22/23 spacing 75 mm	3 399 29/30 spacing 125 mm
	Vertical at the bottom between the functional uprights	L: 16 modules					
		L: 24 modules		3 399 01 + 3 379 81			
		L: 36 modules		3 399 01 + 3 379 82			
	Vertical at the bottom / sleeve	L: 16 modules / 450 mm				3 399 20/23 + 3 399 36/37/38/39 <sup>(8)</sup>	
		L: 24 modules			3 399 06 + 3 397 35	3 399 21/23 + 3 399 36/37/38/39 <sup>(8)</sup>	
		L: 36 modules			3 399 06 + 3 397 36	3 399 22/23 + 3 399 36/37/38/39 <sup>(8)</sup>	
	Main horizontal at the bottom of the enclosure <sup>(7)</sup>	Internal cable sleeve				3 399 20 + 3 399 36/37/38/39 + 3 397 36 x 2	
		Internal cable sleeve with intermediate upright at the bottom				3 399 20 + 3 399 36/37/38/39 + 3 397 37 x 2	
		External cable sleeve L: 350 mm				3 399 20 + 3 399 36/37/38/39 + 3 397 30 x 2	3 399 29 + 3 397 30 x 2
		Sleeve/enclosure L: 450 mm / 16 modules				3 399 20 + 3 399 36/37/38/39 + 3 397 31 x 2	3 399 29 + 3 397 31 x 2
		L: 24 modules				3 399 20 + 3 399 36/37/38/39 + 3 397 35 x 2	3 399 29 + 3 397 35 x 2
		L: 36 modules				3 399 20 + 3 399 36/37/38/39 + 3 397 36 x 2	3 399 29 + 3 397 36 x 2

1: The main horizontal busbar is positioned at the front of the enclosure, vertical busbars are accessible at the front, behind the faceplates (mainly via cable sleeves)  
 2: The main horizontal busbar is positioned at the back of the enclosure and the vertical busbars are accessible at the back of the enclosure by removing the rear panels.  
 3: Junction only possible using a main horizontal busbar at the top or bottom - «C» aluminum bars.  
 4: Partial chassis



Aluminum bars						
700		1750			3500	
630		1600			3200	
3 399 02/03	3 399 04/05	3 399 20 /21/22/23 spacing 75 mm	3 399 31/32/33 spacing 75 mm	3 399 25/26/27 spacing 125 mm	3 399 20 /21/22/23 spacing 75 mm	3 399 25/26/27 spacing 125 mm
	3 399 04/05 + 3 379 80					
	3 399 04/05 + 3 379 81					
	3 399 04/05 + 3 379 82					
		3 399 20/23 + 3 399 40 <sup>(8)</sup>				
		3 399 21/23 + 3 399 40 <sup>(8)</sup>		3 399 25/27 + 3 399 40 <sup>(8)</sup>		
		3 399 22/23 + 3 399 40 <sup>(8)</sup>		3 399 26/27 + 3 399 40 <sup>(8)</sup>		
		3 399 20 + 3 399 40 + 3 397 36 x 2		3 399 25 + 3 399 40 + 397 36 x 2	3 399 20 x 2 <sup>(9)</sup> + 3 397 36 x 3	3 399 25 x 2 <sup>(9)</sup> + 3 397 36 x 3
		3 399 20 + 3 399 40 + 3 397 37 x 2		3 399 25 + 3 399 40 + 397 37 x 2	3 399 20 x 2 <sup>(9)</sup> + 3 397 37 x 3	3 399 25 x 2 <sup>(9)</sup> + 3 397 37 x 3
		3 399 20 + 3 399 40 + 3 397 30 x 2		3 399 25 + 3 399 40 + 397 30 x 2	3 399 20 x 2 <sup>(9)</sup> + 3 397 30 x 3	3 399 25 x 2 <sup>(9)</sup> + 3 397 30 x 3
		3 399 20 + 3 399 40 + 3 397 31 x 2		3 399 25 + 3 399 40 + 397 31 x 2	3 399 20 x 2 <sup>(9)</sup> + 3 397 31 x 3	3 399 25 x 2 <sup>(9)</sup> + 3 397 31 x 3
		3 399 20 + 3 399 40 + 3 397 35 x 2		3 399 25 + 3 399 40 + 397 35 x 2	3 399 20 x 2 <sup>(9)</sup> + 3 397 35 x 3	3 399 25 x 2 <sup>(9)</sup> + 3 397 35 x 3
		3 399 20 + 3 399 40 + 3 397 36 x 2		3 399 25 + 3 399 40 + 397 36 x 2	3 399 20 x 2 <sup>(9)</sup> + 3 397 36 x 3	3 399 25 x 2 <sup>(9)</sup> + 3 397 36 x 3

5: Mounting behind the central upright crosspiece

6: Enclosure equipped with crosspieces

7: Mounting behind the functional uprights

8: Except for a 400 mm depth

9: The two busbars are placed one above the other in the enclosure

# DISTRIBUTION SYSTEM

## 1 FLAT COPPER BARS

### ■ Support Cat.No 3 399 00

**!** For all mountings inside the enclosure, make sure to always use the largest holes (Ø 5.4 mm) to fix the equipment. Smaller holes (Ø 4.6 mm) are used to insert anti-rotation studs. For some mountings, it will be mandatory to remove the screws on the roof to get free space for the supports fixation.

### ■ 400A maximum inclined and staggered copper bar.

The installation needs to be on a crosspiece Cat.No 3 397 34 (depth 400 mm), Cat.No 3 397 35 (depth 600 mm) or Cat.No 3 397 36 (depth 800 mm) to create a lateral vertical internal or external cable sleeve busbar, with an access on the front or on the back.

**i** Depending on the position of the main horizontal busbars at the top or at the bottom of enclosures, depth 600 or 800 mm, the support can be installed either at the front to ease a front access behind the faceplates, or at the back removing the panels.

Composition Cat.No 3 399 00

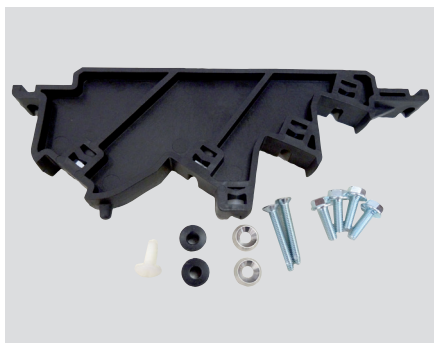

Composition Cat.No 3 397 34



- At first, install the 2 crosspiece's fixing lugs on the structure uprights (1 screw per lug, S.30 Torx, tightening torque 5 N.m).

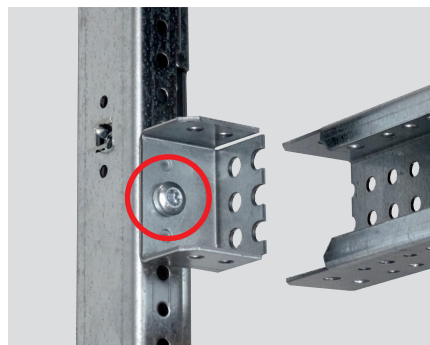

- Fix the crosspiece on the 2 fixing lugs (2 screws per lug, S.30 Torx, tightening torque 5 N.m).



- Fix the support (Cat.No 3 399 00) on the crosspiece using the 2 bigger screws, 2 washers (to join with the screws) and the 2 spacers (to position between the support and the crosspiece) -> S.30 Torx, tightening torque 8 N.m.

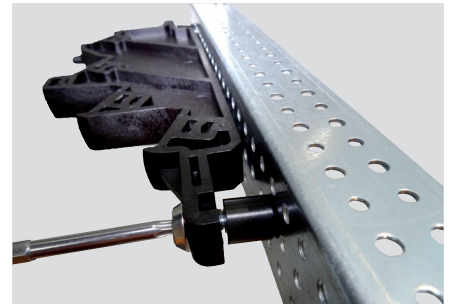

- After having installed all the supports needed and cut the bars at the desired length, fix the bars on each support using the 4 screws provided -> 10 mm hexagon key, tightening torque 10 N.m.

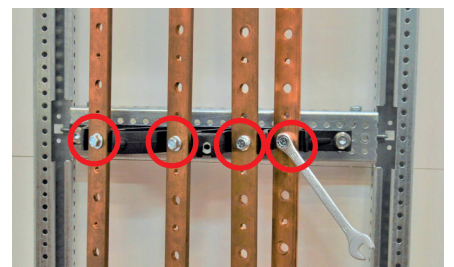

It is possible to fix a protective cover (plexi or other) on the supports using the plastic screw provided (1 per support) → 6 mm flat screwdriver.

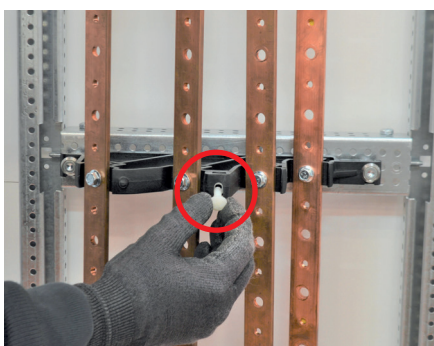

Isolating protective covers can also be fixed (Cat.No 0 373 11) on the bars (between the supports), which enables to increase the cable section (especially those equipped with cable lugs):

- No protective cover →  $\leq 50\text{mm}^2$
- With protective cover →  $\leq 70\text{mm}^2$

### Bars maximum intensity depending on their dimensions and the enclosure's IP :

Cu		I (A)	
		IP ≤ 30	IP > 30
	<b>0 374 34</b> 18 x 4	245	200
	<b>0 374 38</b> 25 x 4	280	250
	<b>0 374 18</b> 25 x 5	330	270
	<b>0 374 19</b> 32 x 5	450	400

### Maximum distance between 2 supports depending on the IPK and bars dimensions :

Cu		Ipk (kA)											
		10	15	20	25	30	35	40	45	50	55		60
	<b>0 374 34</b> 18 x 4	550	400	300	250	200	150	150	-	-	-	-	
	<b>0 374 38</b> 25 x 4	650	600	450	350	300	250	200	150	150	100	-	
	<b>0 374 18</b> 25 x 5	800	700	550	400	350	300	300	200	175	150	150	
	<b>0 374 19</b> 32 x 5	900	800	700	500	400	350	300	200	100	100	-	

# DISTRIBUTION SYSTEM

## SUPPORT CAT.NO 3 399 01

### 400 A maximum aligned copper bars.

The installation needs to be on a crosspiece Cat.No 3 379 81 (24 modules), Cat.No 3 379 82 (36 modules) to create a vertical busbar at the bottom between the functional uprights.

Composition Cat.No 3 399 01 :

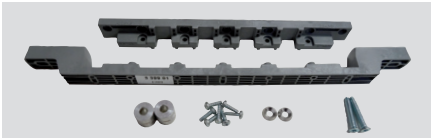

Composition Cat.No 3 379 81 :

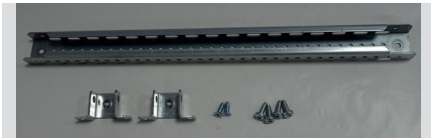

- At first, install the 2 crosspiece's fixing lugs on the functional uprights (2 screws per lug, S.30 Torx, tightening torque 8 N.m).

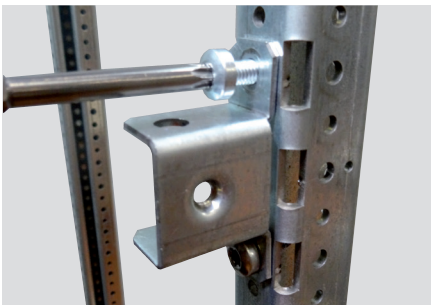

- Fix the crosspiece on the 2 fixing lugs (1 screw per lug, S.30 Torx, tightening torque 8 N.m).



- Fix the rear part of the support on the crosspiece using the 2 bigger screws, 2 washers (to join with the screws) and the 2 spacers (to position between the support and the crosspiece) → S.30 Torx key, tightening torque 8 N.m.



 3 copper bars dimensions are available for this support: 18 mm x 4 mm (Cat.No 0 374 34), 25 mm x 5 mm (Cat.No 0 374 18) and 32 mm x 5 mm (Cat.No 0 374 19).

- After having installed all the rear parts needed and cut the bars at the desired length, position the bars in the supports and position the front part (depending on the bars dimensions). Fix each front part using the 5 screws provided -> empreinte PZ2.

18 mm x 4 mm (Front view) :

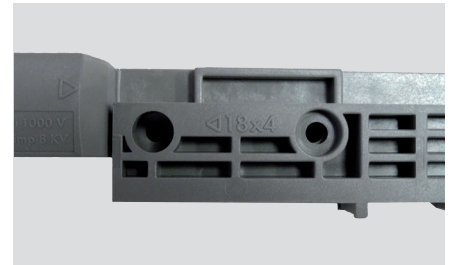

18 mm x 4 mm (Upper view) :



25 mm x 5 mm (Front view) :



25 mm x 5 mm (Upper view) :

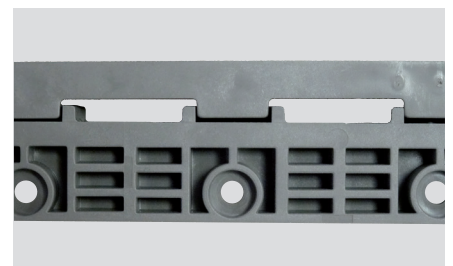

- It is possible to fix a protective cover (plexi or other) on the supports using the 2 screws left (per support) → PZ1. Position of the screws on the supports:



Bars maximum intensity depending on their dimensions and the enclosure's IP :

Cu		I (A)	
		IP ≤ 30	IP > 30
<b>0 374 34</b> 18 x 4		245	200
<b>0 374 18</b> 25 x 5		330	270
<b>0 374 19</b> 32 x 5		450	400

Maximum distance between 2 supports depending on the IPK and bars dimensions :

Cu		Ipk (kA)										
		10	15	20	25	30	40	50	60	70	80	
<b>0 374 34</b> 18 x 4		1000	700	550	400	350	250	200	200	150	150	
<b>0 374 18</b> 25 x 5		1200	1000	750	600	500	350	300	250	200	200	
<b>0 374 19</b> 32 x 5		1500	1200	950	750	650	450	400	300	250	250	



## SUPPORT CAT.NO 3 399 06

### 800 A maximum inclined copper bars.

The installation needs to be on a crosspiece:

- Cat.No 3 397 35 (depth 600 mm) or Cat.No 3 397 36 (depth 800 mm) to create a lateral vertical internal or external cable sleeve busbar, with an access on the front or on the back.
- Cat.No 3 397 35 to create a lateral vertical internal or external cable sleeve busbar in an enclosure (depth 800 mm) behind the functional uprights with an access at the back.
- Cat.No 3 397 35 (depth 600 mm) or Cat.No (depth 800 mm) to create a lateral vertical busbar in a 36 modules enclosure with a central upright, access at the back.
- Cat.No 3 397 35 (24 modules) or Cat.No 3 397 36 (36 modules) to create a vertical busbar into the back of the enclosure.

**i** Depending on the position of the main horizontal busbars at the top or at the bottom of enclosures, depth 600 or 800 mm, the support can be installed either at the front to ease a front access behind the faceplates, or at the back removing the panels.

Composition Cat.No 3 399 06 :



- Fix the 2 lugs, then the crosspiece on the uprights (see pages 5-6), fix the support Cat.No 3 399 06 on the crosspiece using 2 screws -> S.30 Torx, tightening torque 8 N.m.



5 copper bars dimensions are available with this support: 18 mm x 4 mm [Cat.No 0 374 34], 25 mm x 5 mm [Cat.No 0 374 18] and 32 mm x 5 mm [Cat.No 0 374 19], 50 mm x 5 mm [Cat.No 0 374 40], and 63 mm x 5 mm [Cat.No 0 374 41].

- After having installed all the supports needed and cut the bars at the desired length, fix the bars on each support using the 4 screws provided -> 10 mm hexagon key, tightening torque 7 N.m.



Position the plastic washers between the bars and the supports for the 50 mm x 5 mm and 63 mm x 5 mm bars.

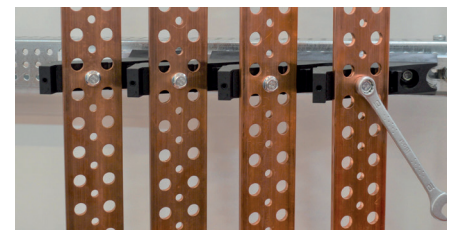

It is possible to fix a protective cover (plexi or other) on the supports using the 2 screws ->PZ1.

Position of the screws :

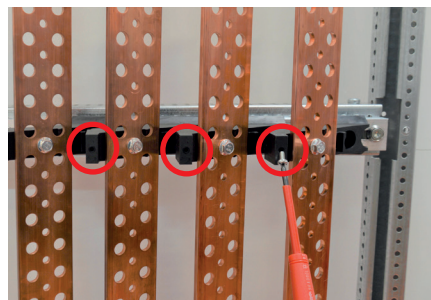

**Bars maximum intensity depending on their dimensions and the enclosure's IP :**

Cu	I (A)	IP	
		IP ≤ 30	IP > 30
<b>0 374 34</b> 18 x 4	245	200	
<b>0 374 18</b> 25 x 5	330	270	
<b>0 374 19</b> 32 x 5	450	400	
<b>0 374 40</b> 50 x 5	700	630	
<b>0 374 41</b> 63 x 5	800	700	

**Maximum distance between 2 supports depending on the IPK and bars dimensions :**

Cu	I <sub>pk</sub> (kA)	I <sub>pk</sub> (kA)											
		10	15	20	25	30	35	40	45	50	60	70	80
<b>0 374 34</b> 18 x 4	800	400	300	250	225	200	175	150	150	125	100	-	
<b>0 374 18</b> 25 x 5	800	600	450	350	300	250	200	200	150	125	100	-	
<b>0 374 19</b> 32 x 5	900	600	500	400	350	300	250	200	150	125	100	-	
<b>0 374 40</b> 50 x 5	-	700	600	500	400	350	275	225	200	150	150	100	
<b>0 374 41</b> 63 x 5	-	800	700	550	450	400	300	250	200	150	150	100	

### SUPPORTS CAT.NO 3 399 29 AND 3 399 30 («FLY» SUPPORT)

#### 4000 A maximum aligned copper bars

Distance between the poles : 125 mm.

The fixed support Cat.No 3 399 29 is directly installed to create :

- A main horizontal busbar, at the top or at the bottom, depth 600 mm or 800 mm (enclosure with a partial chassis) .
- A horizontal transfer busbar inside the enclosure, depth 600 mm or 800 mm.
- A lateral vertical external cable sleeve busbar, width 450 mm, depth 600 or 800 mm.

**!** For a 800 mm depth, the main horizontal busbars need to be installed in the rear position. Vertical busbars are accessible via the back of the enclosure removing the panels.

To create a main horizontal busbar at the back of the enclosure, depth 600 or 800 mm, the support Cat.No 3 399 29 must be fixed using crosspieces Cat.No 3 397 30/31/35/36 depending on the width of your enclosure (see page 70).

Fly busbar support Cat.No 3 399 30 is used to complete the fixed support without being fixed to the enclosure.

**!** The fly support needs to be installed to complete :

- At least 2 fixed supports if there is a horizontal busbar, offside main horizontal busbar into the back of the enclosure (superposed bars) where only the fixed supports can be used,
- At least 3 fixed supports if there is a vertical busbar.

Composition Cat.No 3 399 29 :



Composition Cat.No 3 399 30 :

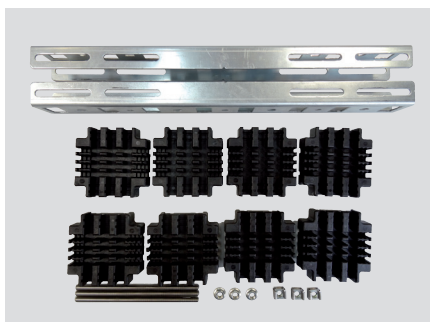

- Position the 8 isolators on the 2 crosspieces of each support respecting the thickness of the bars used.

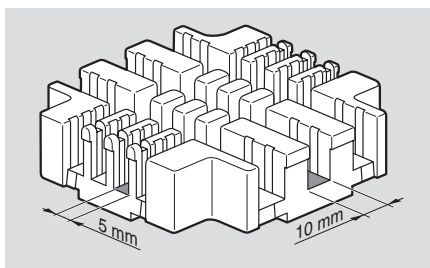

- Equip the fixed crosspiece (with cage-nuts between each insulator) of the supports Cat.No 3399 29 with 2 slides using 8 screws and 8 washers provided (manual clamping). For a 600 mm fixation, previously move the 4 cage-nuts of the bigger slide.

- Position of the bigger slide for a 600 mm fixation



- Position of the bigger slide for a 800 mm fixation

Moving the cage-nuts



(New position)

(Former position)



- Install the fixed part of the supports Cat.No 3 399 29 in the enclosure using the 4 screws provided -> S.30 Torx, tightening torque 8 N.m.

# DISTRIBUTION SYSTEM

Example of a main horizontal busbar at the top – 800 mm :

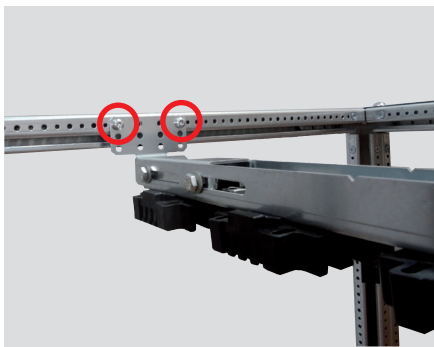

- Install the movable crosspiece of the supports Cat.No 3 399 29 and the complementary fly supports Cat.No 3 399 30 using the 3 threaded rods and the 3 nuts provided with each support -> **keyless manual clamping**.



 These supports can received per pole: from 1 to 4 flat bars, thickness 5 mm up to 125 x 5 mm (Cat.No 0 374 40/41/59/43/46) or 1 to 3 flat bars, thickness 10 mm up to 120 x 10 mm.

- Adjust the position of the busbar regarding the depth to connect it to the other busbars. Block the 8 screws of the fixed part of the supports Cat. No 3 399 29 -> 13 mm hexagon key, tightening torque 20 N.m. Secure the 3 threaded rods and the 3 nuts provided with each support -> 13 mm hexagon key, tightening torque 10 N.m.

Securing the screws of the fixed part :

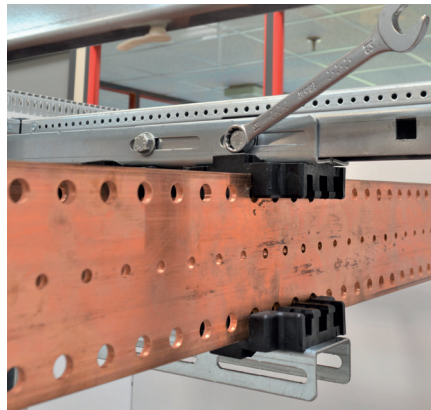

Securing the nuts :

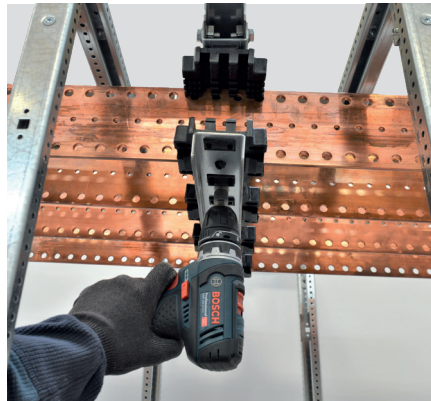

Overview :



To create a main horizontal busbar into the back of the enclosure (depth 600 or 800 mm), the fixed supports Cat.No 3 399 29 need to be installed on the crosspieces in the same way as the mountings mentioned above. Nevertheless, the supports are always equipped with the bigger slide in the "600 mm fixation" position (see page 14).



The crosspieces catalogue numbers needed are :

3 397 30 : sleeve, width 350 mm

3 397 31 : enclosure 16 modules/  
sleeve width 450 mm

3 397 35 : enclosure 24 modules

3 397 36 : enclosure 36 modules

Bars maximum intensity depending on their dimensions, position and the enclosure's IP :

Cu	I (A)		I (A)		I (A)		I (A)		I (A)		I (A)		I (A)		I (A)	
	IP ≤ 30	IP > 30	IP ≤ 30	IP > 30	IP ≤ 30	IP > 30	IP ≤ 30	IP > 30	IP ≤ 30	IP > 30	IP ≤ 30	IP > 30	IP ≤ 30	IP > 30	IP ≤ 30	IP > 30
50 x 5	700	630	500	420	1180	1020	750	630	1600	1380	1000	900	2020	1720	1120	1000
63 x 5	800	700	600	500	1380	1180	750	630	1900	1600	1100	1000	2350	1950	1350	1200
75 x 5	950	850	700	600	1600	1400	1000	850	2200	1900	1250	1100	2700	2300	1600	1400
80 x 5	1000	900	750	630	1700	1480	1050	900	2350	2000	1300	1150	2850	2400	1650	1450
100 x 5	1250	1050	850	700	2050	1800	1200	1050	2900	2450	1600	1400	3500	2900	1900	1650
125 x 5	1450	1270	1000	800	2500	2150	1450	1250	3450	2900	1800	1600	4150	3450	2150	1950
50 x 10	950	850	880	650	1680	1470	1250	1050	2300	2030	2000	1600	-	-	-	-
60 x 10	1150	1020	1000	800	2030	1750	1600	1250	2800	2400	2250	1850	-	-	-	-
80 x 10	1460	1270	1150	950	2500	2150	1700	1500	3450	2900	2500	2000	-	-	-	-
100 x 10	1750	1500	1350	1150	3050	2550	2000	1650	4150	3500	2900	2400	-	-	-	-
120 x 10	2000	1750	1650	1450	3600	3000	2500	2000	4800	4000	3500	3000	-	-	-	-

Maximum distance between 2 supports depending on the l<sub>pk</sub> and bars dimensions :

Cu																				
	50 x 5	63 x 5	75 x 5 80 x 5	100 x 5	125 x 5	50 x 5	63 x 5	75 x 5 80 x 5	100 x 5	125 x 5	50 x 5	63 x 5	75 x 5 80 x 5	100 x 5	125 x 5	50 x 5	63 x 5	75 x 5 80 x 5	100 x 5	125 x 5
l <sub>pk</sub> (kA)																				
10	1250	1300	1350	1700	1700	1550	1700	1700	1700	1700	1700	1700	1700	1700	1700	1700	1700	1700	1700	1700
15	900	950	1000	1350	1500	1000	1350	1700	1700	1700	1400	1450	1500	1700	1700	1600	1700	1700	1700	1700
20	700	750	900	1200	1250	900	1050	1350	1500	1700	1050	1100	1150	1200	1250	1250	1600	1600	1700	1700
25	550	600	800	1100	1150	700	900	1050	1300	1500	850	900	950	1000	1050	1000	1400	1500	1700	1700
30	450	550	700	900	950	600	700	900	1150	1300	700	750	800	850	900	800	1150	1200	1300	1350
35	400	500	600	700	750	500	550	750	900	1100	600	650	700	750	800	700	1050	1100	1200	1250
40	350	450	550	650	700	450	500	650	800	950	500	550	600	650	700	600	950	1000	1050	1100
45	350	400	500	600	650	400	450	550	700	850	450	500	550	600	650	550	850	900	950	1000
50	300	350	450	550	600	350	400	500	600	750	400	450	500	550	600	500	750	800	850	900
60	300	350	400	500	550	300	350	450	550	650	350	400	450	500	550	400	600	650	700	750
70	250	300	350	450	500	250	300	350	450	550	300	350	400	450	500	350	500	550	600	650
80	-	250	300	400	450	-	250	300	400	450	250	300	350	400	450	300	450	500	550	600
90	-	-	250	350	400	-	-	300	400	450	-	250	300	350	400	450	550	600	650	700
100	-	-	-	350	400	-	-	250	300	350	-	-	250	300	400	250	300	350	400	500
110	-	-	-	300	350	-	-	-	250	350	-	-	250	300	350	-	250	300	350	450

Cu															
	50 x 10	60 x 10	80 x 10	100 x 10	120 x 10	50 x 10	60 x 10	80 x 10	100 x 10	120 x 10	50 x 10	60 x 10	80 x 10	100 x 10	120 x 10
l <sub>pk</sub> (kA)															
20	1200	1500	1700	1700	1700	1700	1700	1700	1700	1700	1700	1700	1700	1700	1700
25	1000	1200	1450	1500	1700	1500	1700	1700	1700	1700	1700	1700	1700	1700	1700
30	900	1000	1200	1400	1550	1350	1450	1500	1500	1700	1450	1500	1700	1700	1700
35	800	900	1000	1150	1200	1200	1350	1450	1500	1500	1500	1500	1300	1500	1700
40	700	800	900	1000	1150	1150	1250	1300	1450	1500	1150	1300	1500	1700	1500
45	600	700	750	900	1000	1000	1100	1150	1300	1350	1000	1150	1350	1500	1500
50	500	600	700	800	900	750	900	1000	1150	1250	900	1000	1250	1300	1350
60	400	500	550	650	700	650	700	800	900	1000	750	800	1000	1050	1150
70	350	400	450	550	600	600	650	700	750	800	650	700	800	850	900
80	300	350	400	450	500	450	500	550	650	700	550	600	700	750	800
90	250	300	350	400	450	350	450	500	550	600	500	550	600	650	700
100	250	250	300	350	400	400	300	450	400	450	500	400	450	500	600
110	250	250	250	300	350	250	300	350	400	450	350	400	450	500	500

## 2 FLAT COPPER BARS AND "C" ALUMINUM BARS FLY SUPPORTS CAT.NO 3 399 20/21/22 AND 3 399 23

3000 A maximum aligned copper bars.  
1600 A maximum "C" aligned aluminum bars (3200A maximum doubling the busbar)

Distance between the poles : 75 mm.



For 600 or 800 mm enclosures, the main horizontal busbar (top or bottom) can be positioned either at the front or at the back of the enclosures. In the front position, a front access for vertical busbars is possible behind the plates (via the sleeves). In the rear position, the access to vertical busbars is possible at the back of the enclosure removing the panels.

**The fixed support Cat.No 3 399 20 is directly installed to create :**

- A main horizontal busbar at the top or at the bottom of the enclosure, depth 400 mm (with a partial chassis), or depth 600 mm behind the crosspiece of a central functional upright with a rear access.
- A horizontal transfer busbar into the enclosure, depth 400 mm (enclosure equipped on crosspieces), or into the enclosure, depth 600 mm, behind the functional uprights with a rear access.
- A lateral vertical busbar, internal or external cable sleeve, depth 400 mm<sup>(1)(2)</sup>.
- A lateral vertical busbar, depth 600 mm, behind the functional upright with a rear access<sup>(2)</sup>.
- A vertical busbar into the back of a 16 modules enclosure, depth 600 or 800 mm<sup>(2)</sup>.



For all mountings inside the enclosure, make sure to always use the largest holes (Ø 5.4 mm) to fix the equipment. Smaller holes (Ø 4.6 mm) are used to insert anti-rotation studs. For some mountings, it will be mandatory to remove the screws on the roof to get free space for the supports fixation.

To create a main horizontal busbar into the back of the enclosure depth 600 or 800 mm, the fixed supports Cat.No 3 399 20 need to be installed on the crosspieces Cat.No 3 397 36/37/30/31/35/36 depending on the width of the enclosure (see page 78).

(1) Only possible with a main horizontal «C» busbar

(2) 1600 A maxi «C» aluminum busbars

**The fixed support Cat.No 3 399 21 is directly installed to create :**

- A main horizontal busbar at the top or at the bottom of the enclosure, depth 600 mm with a front access (enclosure with a partial chassis) or rear access, or depth 800 mm behind the central functional upright's crosspiece, with a rear access.
- A horizontal transfer busbar into the enclosure, depth 600 mm, with a front or rear access (enclosure equipped on crosspieces), or in a 800 mm depth enclosure behind the functional uprights with a rear access.
- A lateral vertical busbar, internal or external cable sleeve, depth 600 mm, with a front or rear access<sup>(3)</sup>.
- A lateral vertical busbar in the enclosure, depth 800 mm behind the functional upright with a rear access<sup>(2)</sup>.
- A vertical busbar into the back of the enclosure, 24 modules, depth 600 or 800 mm<sup>(2)</sup>.

(2) 1600A maximum "C" aluminum bars.

(3) 1600A maximum internal sleeve "C" aluminum bars.

**The fixed support Cat.No 3 399 22 is directly installed to create :**

- A main horizontal busbar at the top or at the bottom of the enclosure, depth 800 mm with a front access (partial chassis).
- A horizontal transfer busbar, depth 800 mm, with front or rear access (equipped on crosspieces).
- Lateral vertical busbar, internal or external cable sleeve, depth 800 mm with front or rear access<sup>(3)</sup>.
- Vertical busbar into the back of a 36 modules enclosure, depth 600 or 800 mm<sup>(2)</sup>.

(2) 1600 A maxi. «C» aluminum busbars

(3) 1600A maximum internal sleeve "C" aluminum bars.

The fly support Cat.No 3 399 23 is used to complete the fixed supports without being fixed to the enclosure. This support is also used to double a "C" aluminum busbar up to 3200A maximum.



**The fly support Cat.No 3 399 23 is used to complete :**

- At least 2 fixed supports in case of horizontal busbars, apart from main horizontal busbars at the bottom of the enclosure (busbars juxtaposed) where only the fixed supports must be used.
- At least 3 fixed supports in case of vertical busbars.



Composition Cat.No 3 399 20

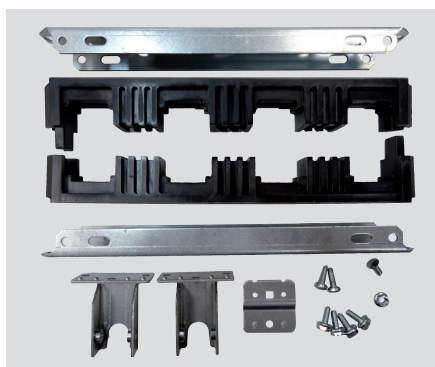

Composition Cat.No. 3 399 23

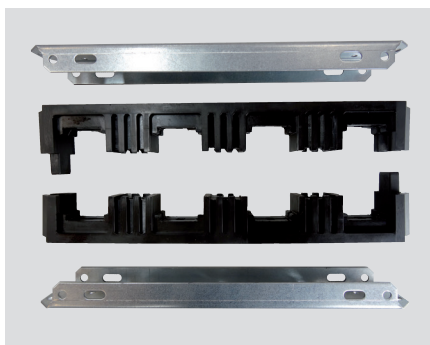

Composition Cat.No 3 399 36



Composition Cat.No 3 399 21



**!** Each support, Cat.No 3 399 20/21/22 and 3 399 23 needs to be completed with a kit for bus-bar supports depending on the type and dimensions of the bars used :

- Kit Cat.No 3 399 36 for flat copper bars 50 x 5 (0 374 40) or 63 x 5 mm (0 374 41),
- Kit Cat.No 3 399 37 for flat copper bars 75 x 5 (0 374 59), 80 x 5 (0 374 43) 100 x 5 (0 374 46) or 125 x 5 mm,
- Kit Cat.No 3 399 38 for flat copper bars 50 x 10 or 60 x 10 mm,
- Kit Cat.No 3 399 39 for flat copper bars 80 x 10, 100 x 10 or 120 x 10 mm,
- Kit Cat.No 3 399 40 for "C" aluminum bars Cat.No 0 373 54/55/56/57/58 (1600 A maximum)
- Kit Cat.No 3 399 24 for doubled "C" aluminum bars (3200 A maximum)

Composition Cat.No 3 399 22

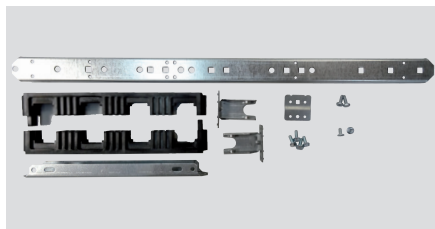

Composition Cat.No 3 399 37



# DISTRIBUTION SYSTEM

Composition Cat.No 3 399 38



Composition Cat.No 3 399 40



Composition Cat.No 3 399 39

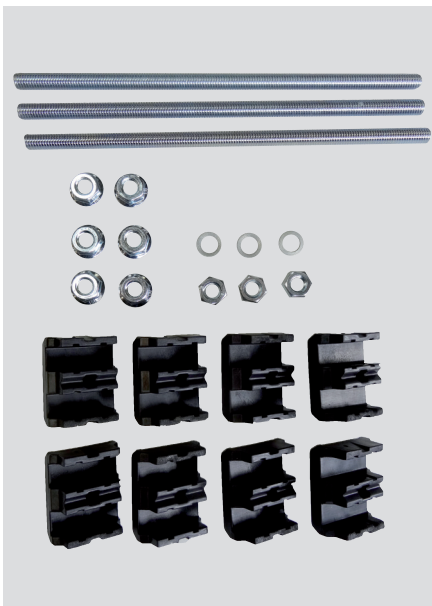

Composition Cat.No 3 399 24

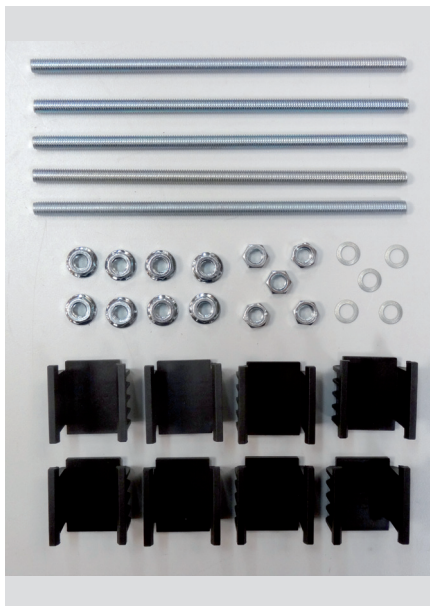

- Equip a support crosspiece Cat.no 3 399 20 or the bigger crosspiece of the supports Cat.No 3 399 21/22 using the 2 fixing lugs and the 4 screws provided using the oblongs holes -> keyless manual clamping.

Example on a main crosspiece :



To create a busbar into the back of the enclosure 16 modules, depth 450 mm, use the rounded holes on the edges of the support crosspiece Cat.No 3 399 20.



- Assemble a half isolating part on the crosspiece equipped with the fixed support (or on crosspiece fly busbar support Cat.No 3 399 23) using the threaded rods/screws, nuts and washers provided in the kit ->13 mm hexagon key, tightening torque 20 N.m.

Assembly with kits  
Cat.No 3 399 36/37/38/39

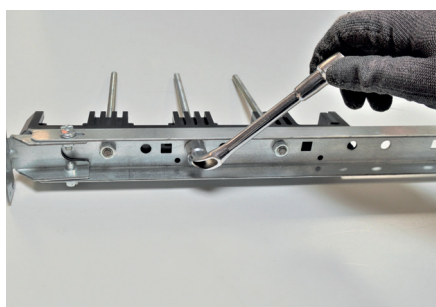
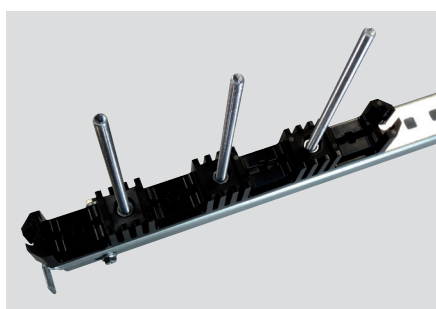
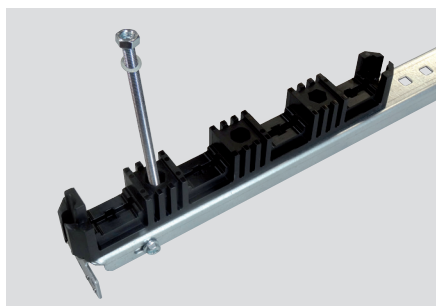

Assembly with kit Cat.No 3 399 40.



To create a busbar into the back of the enclosure 24 or 36 modules, you need to position the half isolating part in the middle of the crosspiece equipped with the supports Cat.No 3 399 21/22.



- Regarding copper busbar, you need to position 8 adapters for flat bars, thickness 5 or 10 mm provided with the kits Cat.Nos 3 399 36/37/38/39 in the 2 half isolating parts.

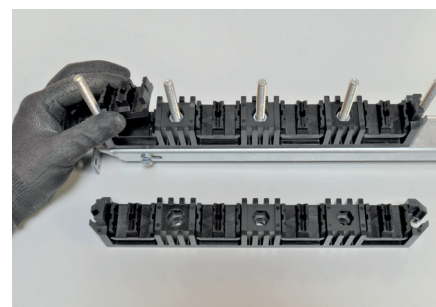

- Install the fixed part of the supports Cat.No 3 399 20/21/22 in the enclosure using the 2 screws provided --> S.30 Torx, tightening torque 8 N.m.



**!** To create a busbar behind the functional upright, the supports Cat.Nos 3 399 20/21 need to be installed in the enclosure with the lug provided previously fixed on the rear structure upright using a Torx screw provided --> S.30 Torx, tightening torque 8 N.m. The support is then fixed using the Torx screw left, et the screw and the M6 nut provided on the lug's side --> S.30, tightening torque 8 N.m. – 10 mm hexagon key, tightening torque 10 N.m.



# DISTRIBUTION SYSTEM



These supports can receive per pole: from 1 to 4 flat bars, thickness 5 mm up to 125 x 5 mm (Cat.No 0 374 40/41/59/43/46) or 1 to 3 flat bars, thickness 10 mm up to 120 x 10 mm or 1 "C" aluminum bar Cat. Nos 3 373 54/55/56/57/58.

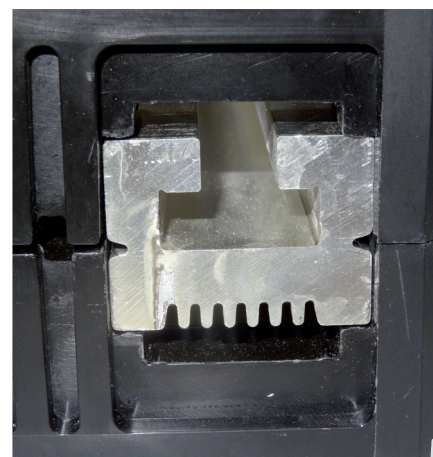
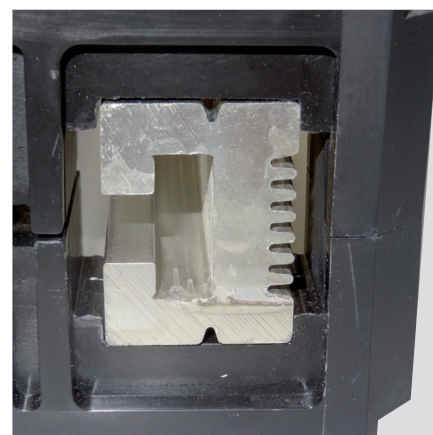

- Install the 2nd half isolating part then the movable supports' crosspiece Cat.No 3 399 20/21/22 using the nuts provided with the kits for the supports --> 13 mm hexagon key, tightening torque 20 N.m. Install in the same way the complementary fly busbar support using a kit Cat.No 3 399 36/37/38/39/40.

**Installation with kits**  
**Cat.No 3 399 36/37/38/39**

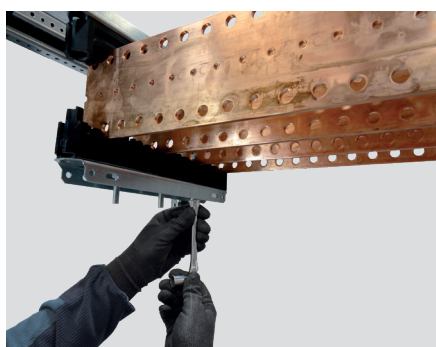

**Installation with the kit**  
**Cat.No 3 399 40**



 The supports Cat.No 3 399 20/21/22 are also used as a low C bar support for vertical "C" aluminum busbar using the accessories provided in the kit Cat.No 3 399 40/24 :

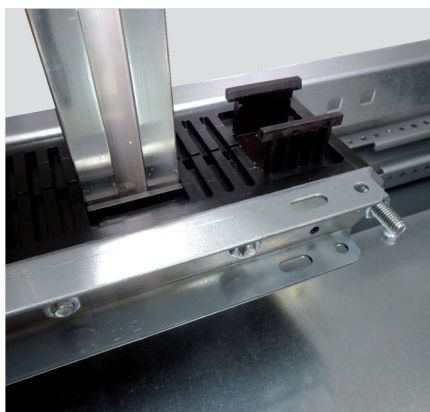

- Adjust the position of the busbar regarding the depth to connect to the other busbars, then block the 4 screws of the fixed part of the supports Cat.No 3 399 20/21/22 --> 10 mm hexagon head, tightening torque 10 N.m.

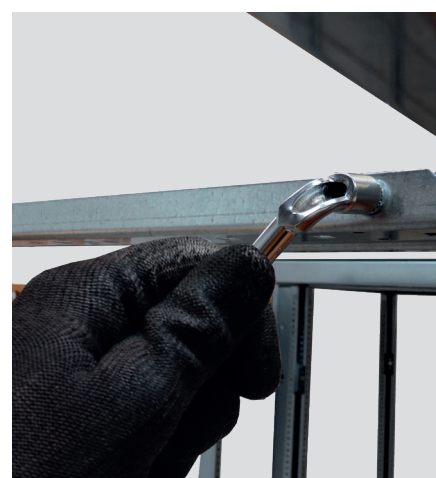



# DISTRIBUTION SYSTEM

**i** To create a “C” aluminum busbar up to 3200A, the fly support Cat.No is used to double the fixed supports Cat.No 3 399 20/21/22 using the kit for busbar supports Cat.No 3 399 24 :



To create a main horizontal busbar into the back of the enclosure (depth 600 or 800 mm), the fixed support Cat.No 3 399 20 needs to be installed on the crosspieces in the same way as the mountings previously detailed. If there is a distribution with “C” aluminum bars exceeding 1600 A (3200 A maximum), 2 busbars are positioned one above the other in the enclosure.

Example with copper bars :

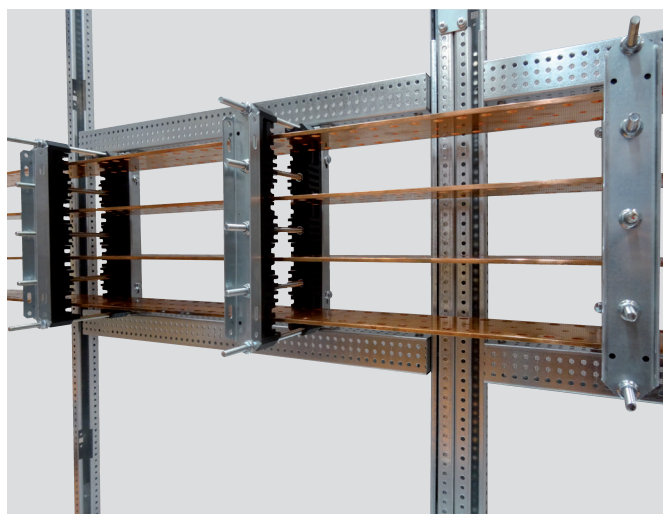

The Cat.No for crosspieces depending on the enclosures are :

- 3 397 30 : sleeve, width 350 mm
- 3 397 31 : enclosure 16 modules, sleeve – width 450 mm
- 3 397 35 : enclosure 24 modules
- 3 397 36 : enclosure 36 modules

Bars maximum intensity depending on their type, dimensions, positions and the enclosure's IP :

Cu	I (A)		I (A)		I (A)		I (A)		I (A)		Al	I (A)				
	IP ≤ 30	IP > 30	IP ≤ 30	IP > 30	IP ≤ 30	IP > 30	IP ≤ 30	IP > 30	IP ≤ 30	IP > 30			IP ≤ 30	IP > 30	IP ≤ 30	IP > 30
50 x 5	700	630	430	350	1150	1000	650	510	1600	1380	1000	900	800	630	630	500
63 x 5	800	700	500	400	1350	1150	770	590	1900	1600	1100	1000	1000	800	800	630
75 x 5	950	850	600	475	1500	1300	890	700	2200	1900	1250	1100	1250	1000	1000	800
80 x 5	1000	900	630	500	1650	1450	940	740	2350	2000	1300	1150	1450	1250	1000	800
100 x 5	1250	1050	750	580	1900	1600	1120	900	2900	2450	1600	1400	1750	1600	1400	1250
125 x 5	1450	1270	1000	800	2500	2150	1450	1250	3450	2900	1800	1600	2150	1900	1600	1400
50 x 10	950	850	880	650	1680	1470	1250	1050	-	-	-	-	1450	1250	1250	1000
60 x 10	1150	1020	1000	800	2030	1750	1600	1250	-	-	-	-	1600	1600	1400	1250
80 x 10	1460	1270	1150	950	2500	2150	1700	1500	-	-	-	-	2150	2000	1650	1650
100 x 10	1750	1500	1350	1150	3050	2550	2000	1650	-	-	-	-	2550	2000	1650	1650
120 x 10	2000	1750	1650	1450	3600	3000	2500	2000	-	-	-	-	3000	2500	2000	2000

Maximum distance between 2 supports depending on the lpk and bars dimensions :

Cu															
	50 x 5	63 x 5	75 x 5 80 x 5	100 x 5	125 x 5	50 x 5	63 x 5	75 x 5 80 x 5	100 x 5	125 x 5	50 x 5	63 x 5	75 x 5 80 x 5	100 x 5	125 x 5
l <sub>pk</sub> (kA)															
10	1500	1500	1500	1600	1700	1550	1700	1700	1700	1700	1700	1700	1700	1700	1700
15	1300	1050	1300	1350	1500	1200	1200	1500	1700	1700	1350	1400	1500	1700	1700
20	950	950	1000	1000	1250	900	1150	1300	1500	1700	950	1000	1100	1500	1500
25	750	800	850	900	1000	700	900	1150	1300	1400	800	900	1000	1300	1350
30	600	600	650	700	800	600	800	900	1050	1150	650	800	900	1150	1200
35	500	500	550	600	700	500	700	800	900	1000	550	700	800	900	1000
40	450	450	500	550	600	450	600	700	750	850	500	650	750	850	950
45	400	400	450	500	550	400	500	600	650	750	450	550	650	750	850
50	350	350	400	450	500	350	450	550	650	700	400	500	600	700	800
60	300	300	350	400	450	300	500	550	600	550	300	400	500	550	650
70	250	250	300	350	400	250	300	400	450	500	250	300	400	500	600
80	200	250	250	300	350	200	250	300	350	400	250	300	350	400	500
90	200	200	250	250	300	200	250	300	350	350	200	250	300	350	450
100	150	200	200	250	250	150	200	250	300	350	200	250	300	350	350
110	150	150	200	250	250	150	150	200	250	300	150	150	250	300	350

Cu											Al						
	50 x 10	60 x 10	80 x 10	100 x 10	120 x 10	50 x 10	60 x 10	80 x 10	100 x 10	120 x 10		0 373 54	0 373 55	0 373 56	0 373 57	0 373 58	0 373 58 x2
l <sub>pk</sub> (kA)																	
20	1700	1700	1700	1700	1700	1700	1700	1700	1700	1700	1800	1800	1800	1800	1800	1800	
25	1500	1500	1700	1700	1700	1700	1700	1700	1700	1700	1800	1800	1800	1800	1800	1800	
30	1200	1350	1500	1700	1700	1450	1500	1600	1700	1700	1800	1800	1800	1800	1800	1800	
35	1000	1150	1400	1500	1700	1250	1300	1500	1600	1600	1600	1600	1600	1600	1600	1600	
40	900	1000	1250	1300	1600	1050	1250	1300	1500	1600	1600	1600	1600	1600	1600	1600	
45	800	900	1050	1150	1400	950	1100	1200	1300	1500	1600	1600	1600	1600	1600	1600	
50	700	800	900	1000	1100	850	900	1100	1200	1400	1600	1600	1600	1600	1600	1600	
60	600	700	800	900	1000	700	800	900	1000	1150	1600	1600	1600	1600	1600	1600	
70	550	600	700	750	800	600	700	800	900	1000	1600	1600	1600	1600	1600	1600	
80	500	550	550	600	700	500	550	600	700	800	1600	1600	1600	1600	1600	1600	
90	450	500	550	600	650	450	500	550	650	700	1600	1600	1600	1600	1600	1600	
100	400	400	400	500	500	400	450	500	550	600	1600	1600	1600	1600	1600	1600	
110	350	350	350	350	350	350	350	400	450	450	1600	1600	1600	1600	1600	1600	

# DISTRIBUTION SYSTEM

## 3 "C" ALUMINUM BARS

### SUPPORTS CAT.NO 3 399 02 & 3 399 03 (LOW)

#### 630 A maximum staggered « C » aluminum bars.

The installation is performed on cross-pieces :

- Cat.No 3 397 34 (depth 400 mm), Cat.No 339735 (depth 600 mm) or Cat.No 3 397 36 (depth 800 mm) to create a lateral vertical internal or external cable sleeve busbar, with an access on the front or on the back,
- Cat.No 3 397 35 (depth 600 mm) or Cat.No 3 397 36 (depth 800 mm) to create a lateral vertical busbar into the enclosure behind the functional uprights, with a back access.



Depending on the position of the main horizontal busbars at the top or at the bottom of enclosures, depth 600 or 800 mm, the support can be installed either at the front to ease a front access behind the faceplates, or at the back removing the panels.

Composition Cat.No 3 399 02 :



- Fix the 2 lugs, then the crosspiece on the uprights (see pages 6-7), then fix the rear part of the support on the crosspiece using 2 screws --> S.30 Torx, tightening torque 8 N.m.

- After having installed all the rear parts of the supports, position the 4 plastic items provided with each support --> Cat.No 3 399 02 .



3 aluminum bars catalogue numbers are available for this support: Cat.No 4 044 30 (up to 320A\*), 4 044 31 (up to 500A\*) and 4 044 32 (up to 700A\*).

\* Installed in a IP ≤ 30 enclosure

- Cut the bars at the desired length, then position the 4 plastic items provided with each support (Cat.No 3 399 03) on the edges of the 4 aluminum bars (pay attention to the position).

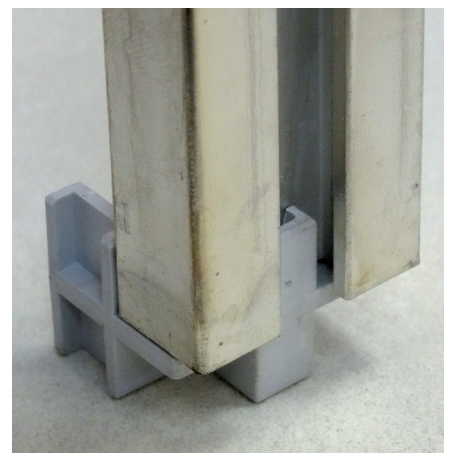
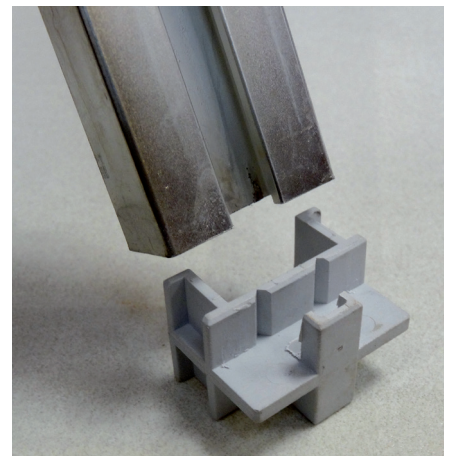

- Install the bars, starting from the equipped edge in the low C bar support, then fix the front parts of the supports using 3 screws and 3 washers provided with each support --> 4 mm Allen key, tightening torque 7 N.m.

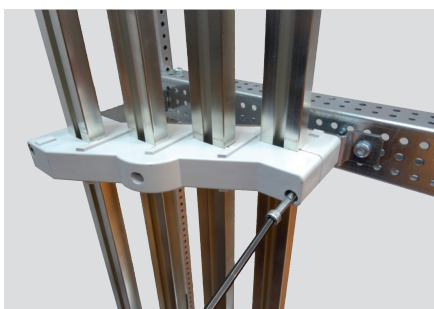
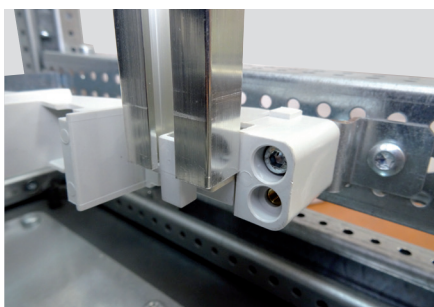

**Bars maximum intensity depending on their type, dimensions, position and the enclosure's IP :**

Al

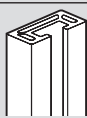
		I (A)	
		IP ≤ 30	IP > 30
	<b>4 044 30</b>	320	250
	<b>4 044 31</b>	500	400
	<b>4 044 32</b>	700	630

**Maximum distance between 2 supports depending on the I<sub>pk</sub> and bars dimensions :**

Al

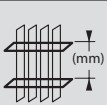
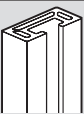
		I <sub>pk</sub> (kA)												
		10	15	20	25	30	35	40	45	50	60	70	80	
	<b>4 044 30</b>	1600	1200	800	600	400	350	300	250	250	-	-	-	
	<b>4 044 31</b>	1600	1200	800	650	500	450	400	350	300	250	175	100	
	<b>4 044 32</b>	1600	1200	800	650	500	450	400	350	300	250	175	100	



# DISTRIBUTION SYSTEM

## SUPPORTS CAT.NO 3 399 04 AND 3 399 05 (LOW)

### ■ 630 A maximum aligned “C” aluminum bars.

The installation is performed on crosspiece: Cat.No 3 379 80 (16 modules), 3 379 81 (24 modules) or 3 379 82 (36 modules) to create a vertical busbar into the back, between the functional uprights.

Composition Cat.No 3 399 04 :

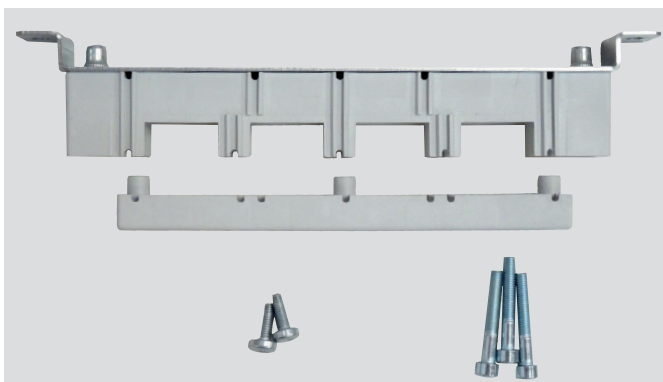

- Fix the 2 lugs, then the crosspiece on the uprights (see page 66), then fix the rear part of the support on the crosspiece using 2 screws, including one from a low C bar support Cat.No 3 399 05 at the bottom of the busbar --> S.30 Torx, tightening torque 8 N.m.

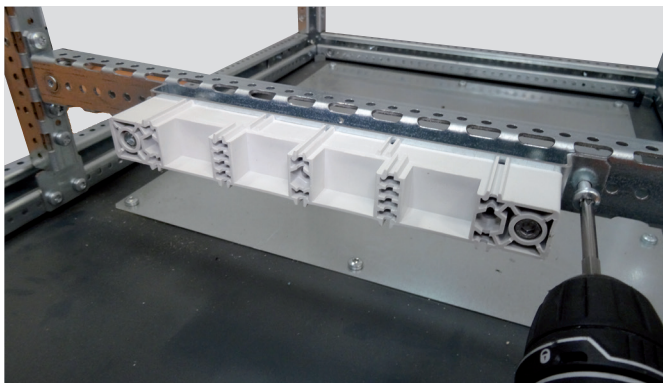

3 aluminum bars catalogue numbers are available for this support: Cat.No 4 044 30 (up to 320 A\*), 4 044 31 (up to 500 A\*) and 4 044 32 (up to 700 A\*)

\*Installed in a IP ≤ 30 enclosure

- Cut the bars at the desired length, then fix the front part of the supports using 3 screws and 3 washers provided with each support --> 5 mm Allen key, tightening torque 7 N.m.

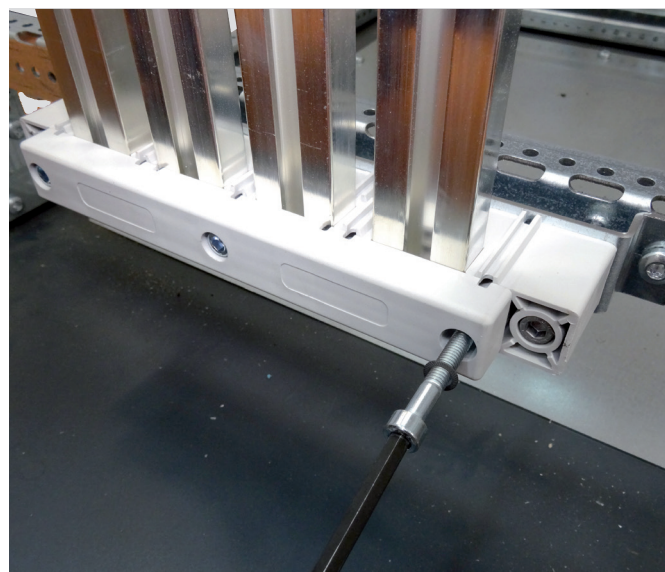

Bars maximum intensity depending on their type, dimensions, position and the enclosure's IP :

AI



	I (A)	
	IP ≤ 30	IP > 30
4 044 30	320	250
4 044 31	500	400
4 044 32	700	630

Maximum distance between 2 supports depending on the Ipk and bars dimensions :

AI

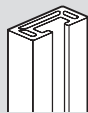

	Ipk (kA)											
	10	15	20	25	30	35	40	45	50	60	70	80
4 044 30	1600	1200	800	600	400	350	300	250	250	-	-	-
4 044 31	1600	1200	800	650	500	450	400	350	300	250	175	100
4 044 32	1600	1200	800	650	500	450	400	350	300	250	175	100

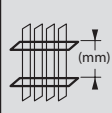

# DISTRIBUTION SYSTEM

## SUPPORTS CAT.NO 3 399 31/32/33

- 1600 A maximum staggered "C" aluminum bars.

Distance between the poles : 75 mm.

Supports Cat.No 3 399 31/32/33 are directly installed to create a lateral vertical busbar, external sleeve, depth 400/600/800.

**i** Depending on the position of the main horizontal busbars at the top or at the bottom of enclosures, depth 600 or 800 mm, the support can be installed either at the front to ease a front access behind the faceplates, or at the back removing the panels.

Composition Cat.No 3 399 31 :

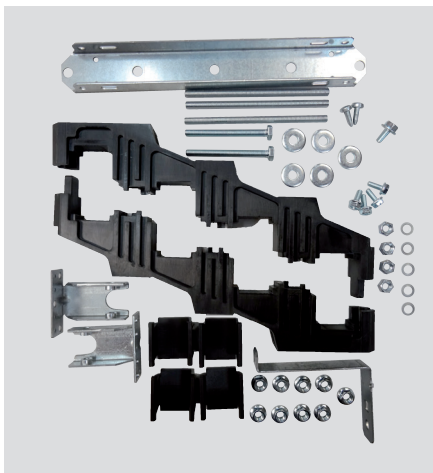

Composition Cat.No 3 399 32 :

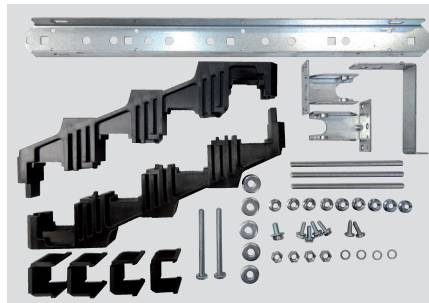

Composition Cat.No 3 399 33 :

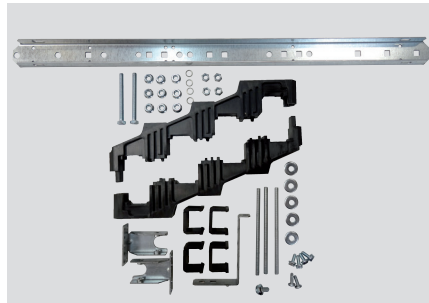

Example with a main crosspiece :

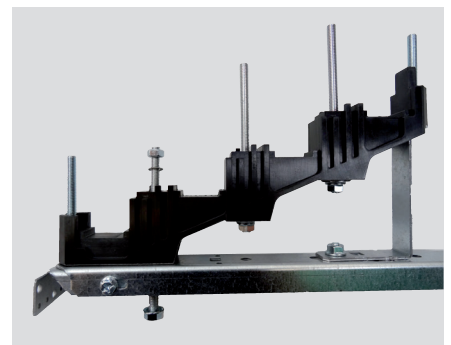
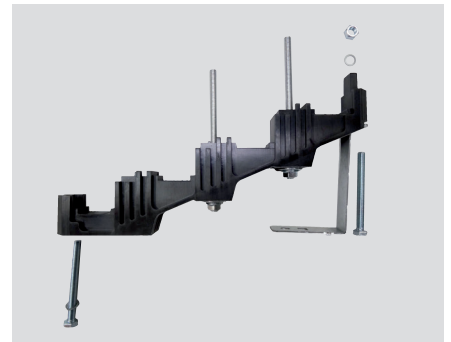
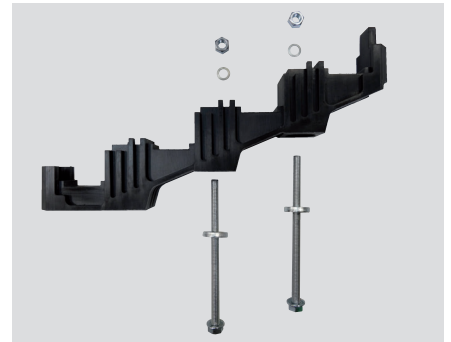

- Equipped with 2 fixing lugs the cross-piece Cat.No 3 399 31 or the bigger crosspiece of the supports 3 399 32/33 using the 4 screws provided using the oblong holes ( see picture 74) -> keyless manual clamping.
- Assemble a half isolating part on the crosspiece equipped with the fixed support using the threaded rods/ screws, nuts, washers and the lug provided in the kit --> 13 mm hexagon key, tightening torque 20 N.m, if not fixed on the crosspiece, 10 N.m.

- Install the fixed part of the supports in the enclosure using the 2 screws provided (see page 75) --> S.30 Torx, tightening torque 8 N.m.

 These supports can receive 1 C aluminum bar per pole Cat.Nos 0 373 54/55/56/57/58 (up to 800/1000/1250/1450/1750 A installed into the enclosure with an IP ≤ 30).

- Install the 2nd half isolating part using 5 nuts and 3 washers provided --> 13 mm hexagon key, tightening torque 20 N.m.



The supports Cat.No 3 399 31/32/32 are also used as a low C bar support for vertical "C" aluminum busbar using the 4 accessories provided.

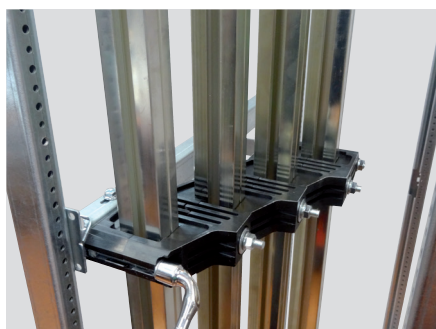
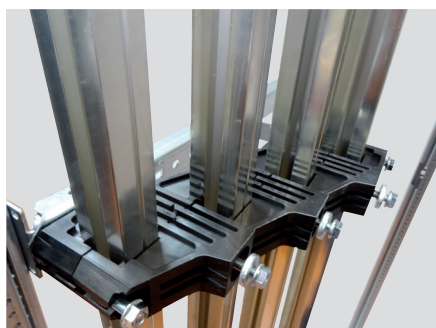
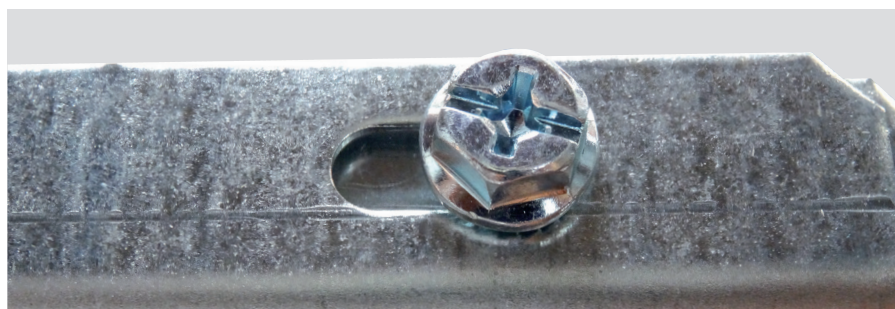

- Adjust the position of the busbar regarding the depth. Block the 4 screws of the fixed part of the supports --> 10 mm hexagon key, tightening torque 10 N.m.



Bars maximum intensity depending on the catalogue number and the enclosure IP :

Maximum distance between 2 supports depending on the catalogue number and the enclosure Ipk :

Al	I (A)	
	IP ≤ 30	IP > 30
 0 373 54	800	630
0 373 55	1000	800
0 373 56	1250	1000
0 373 57	1450	1250
0 373 58	1750	1600

Al 	0 373 54	0 373 55	0 373 56	0 373 57	0 373 58
Ipk (kA)					
10	1600	1600	1600	1600	1600
15	1600	1600	1600	1600	1600
20	1600	1600	1600	1600	1600
25	1600	1600	1600	1600	1600
30	1600	1600	1600	1600	1600
35	1600	1600	1600	1600	1600
40	1000	1000	1000	1000	1000
45	900	900	900	900	900
50	800	800	800	800	800
60	700	700	700	700	700
70	600	600	600	600	600
80	600	600	600	600	600
90	500	500	500	500	500
100	500	500	500	500	500
110	500	500	500	500	500



## SUPPORTS

### CAT.NO 3 399 25/26 AND 3 399 27

■ **1600 A maximum aligned C aluminum bars (3200A maximum when doubling).**

Distance between the poles : 125 mm.



For 800 mm enclosures, the main horizontal busbar (top or bottom) can be positioned either at the front or at the back of the enclosures. In the front position, a front access for vertical busbars is possible behind the plates (via the sleeves). In the rear position, the access to vertical busbars is possible at the back of the enclosure removing the panels.

The fixed support Cat.No 3 399 25 is directly installed to create :

- A main horizontal busbar at the top or at the bottom of the enclosure, depth 600 mm (with a partial chassis), or depth 800 mm behind the crosspiece of a central functional upright with a rear access.
- A horizontal transfer busbar into the enclosure, depth 600 mm (enclosure equipped on crosspieces), or into the enclosure, depth 800 mm, behind the functional uprights with a rear access.
- A lateral vertical busbar, internal or external cable sleeve, depth 600 mm, 1600 A maximum if internal sleeve.
- A lateral vertical busbar, depth 800 mm, behind the functional upright with a rear access (1600 A maximum).
- A vertical busbar into the back of a 24 modules enclosure, depth 600 or 800 mm (1600 A max.).

To create a main horizontal busbar at the back of the enclosure, depth 600 or 800 mm, the support Cat.No 3 399 25 must be fixed using crosspieces Cat.No 3 397 36/37/30/31/35 depending on the width of your enclosure (see page 78).

The fixed support Cat.No 3 399 26 is directly installed to create :

- A main horizontal busbar at the top or at the bottom of the enclosure, depth 800 mm (with a partial chassis with a front or rear access).
- A horizontal transfer busbar into the enclosure, depth 800 mm (enclosure equipped on crosspieces) with a front or rear access.
- A lateral vertical busbar, internal or external cable sleeve, depth 800 mm, 1600 A maximum if internal sleeve; with a front or rear access.
- A vertical busbar into the back of a 36 modules enclosure, depth 600 or 800 mm (1600 A max.).

The fly support Cat.No 3 399 27 is used to complete the fixed supports without being fixed to the enclosure. This support is also used to double a "C" aluminum busbar up to 3200 A maximum.



**The fly support needs to be installed to complete:**

- At least 2 fixed supports if there is a horizontal busbar, offside main horizontal busbar into the back of the enclosure (normal bars) where only the fixed supports can be used;
- At least 3 fixed supports if there is a vertical busbar.

Composition Cat.No 3 399 25 :

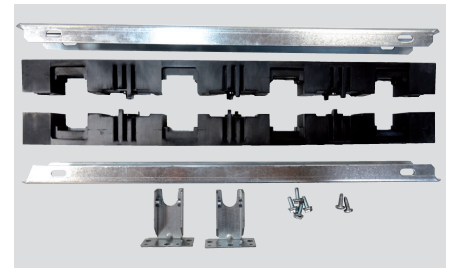

Composition Cat.No 3 399 26 :



Composition Cat.No 3 399 27 :

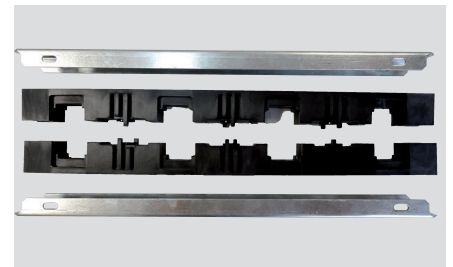

**!** Each support, Cat.No 3 399 25/26/ and 3 399 27, needs to be completed with a kit for busbar supports Cat.No 3 399 40/24 :

- Kit Cat.No 3 399 40 for "C" aluminum bars Cat.No 0 373 54/55/56/57/58 (1600 A maximum).
- Kit Cat.No 3 399 24 for doubled "C" aluminum bars (3200 A maximum).

- Equip a support crosspiece Cat.no 3 399 25 or the bigger crosspiece of the supports Cat.No 3 399 26 using 4 screws provided (see 74) --> manual clamping.

- Assemble a half isolating part on the crosspiece equipped with the fixed support (or on crosspiece fly busbar support Cat.No 3 399 23) using the screws, nuts and washers provided in the kit 3 399 40 (see page 20) --> 13 mm hexagon key, tightening torque 20 N.m. .

To create a busbar into the back of the enclosure 36 modules, you need to position the half isolating part in the middle of the crosspiece equipped with the supports Cat.No 3 399 26 (see picture page 75).

- Install the fixed part of the supports Cat. Nos 3 399 25/26 in the enclosure using the 2 screws provided (see page 75) --> S.30 Torx, tightening torque 8 N.m.

**!** To create a busbar behind the functional upright in 800 mm enclosures, the supports Cat.Nos 3 399 25 need to be installed in the enclosure with the lug provided previously fixed on the rear structure upright using a Torx screw provided --> S.30 Torx, tightening torque 8 N.m.

The support is then fixed using the Torx screw left, et the screw and the M6 nut provided on the lug's side --> S.30, tightening torque 8 N.m. – 10 mm hexagon key, tightening torque 10 N.m.

**+** These supports can received 1 C aluminum bar per pole Cat.Nos 0 373 54/55/56/57/58 (up to 800/1000/1250/1450/1750A installed into the enclosure with an IP ≤ 30).

- Install the 2nd half isolating part then the movable supports' crosspiece Cat.No 3 399 25/26 using the nuts provided with the kits for the supports --> 13 mm hexagon key, tightening

torque 20 N.m. Install in the same way the complementary fly busbar support using a kit Cat.No 3 399 40 (see page 75).

**+** The supports Cat.No 3 399 25/26 are also used as a low C bar support for vertical "C" aluminum busbar using the accessories provided in the kit Cat.No 3 399 40/24 (see page 71).

- Adjust the position of the busbar regarding the depth. Block the 4 screws of the fixed part of the supports Cat.No 3 399 25/26 --> 10 mm hexagon key, tightening torque 10 N.m.



**i** To create a "C" aluminum busbar up to 3200 A, the fly support Cat.No 3 399 27 is used to double the fixed supports Cat.No 3 399 25/26 using the kit for busbar supports Cat.No 3 399 24.

To create a main horizontal busbar into the back of the enclosure (depth 600 or 800 mm), the fixed support Cat.No 3 399 25 needs to be installed on the crosspieces in the same way as the mountings mentioned above. Nevertheless, in case of a distribution higher than 1600 A (3200 A max.) two busbars are positioned one above the other in the enclosure (see picture page 78).

The crosspieces catalogue numbers

needed are :

3 397 30: sleeve, width 350 mm

3 397 31: enclosure 16 modules / sleeve width 450 mm

3 397 35: enclosure 24 modules

3 397 36: enclosure 36 modules

**Bars maximum intensity depending on their catalogue numbers, number, position and the enclosure's IP :**

AI	I (A)				
	IP ≤ 30		IP > 30		
	IP ≤ 30	IP > 30	IP ≤ 30	IP > 30	
	0 373 54	800	630	630	500
	0 373 55	1000	800	800	630
	0 373 56	1250	1000	1000	800
	0 373 57	1450	1250	1250	1000
0 373 58	1750	1600	1400	1250	
	0 373 58 x2	3500	3200	2400	2000

**Maximum distance between 2 supports depending on the lpk and bar's catalogue number :**

AI						
lpk (kA)	0 373 54	0 373 55	0 373 56	0 373 57	0 373 58	0 373 58 x2
10	1800	1800	1800	1800	1800	1800
15	1800	1800	1800	1800	1800	1800
20	1800	1800	1800	1800	1800	1800
25	1600	1600	1600	1600	1600	1600
30	1600	1600	1600	1600	1600	1600
35	1200	1200	1200	1200	1200	1200
40	1200	1200	1200	1200	1200	1200
45	1000	1000	1000	1000	1000	1000
50	1000	1000	1000	1000	1000	1000
60	900	900	900	900	900	900
70	800	800	800	800	800	800
80	800	800	800	800	800	800
90	700	700	700	700	700	700
100	700	700	700	700	700	700
110	700	700	700	700	700	700

# OTHER ACCESSORIES

## BLANKING PLATES

**5 MODULES (CAT.NO 0 016 60)**  
**24 MODULES (CAT.NO 3 397 54)**

Blanking plates enable to fill XL<sup>3</sup> S 630 faceplates modular windows.

You can use 5 Modules shutters Cat.No 0 016 60, white RAL9003, scored in a half-module.

You can also use 24 Modules shutters Cat.No 3 397 54.

### ■ Mounting example: blanking plates Cat.No 0 016 60 :

First, insert the lower part of your blanking plates in the modular window.



Clip the upper part pushing towards the faceplate.



### ■ Mounting example: blanking plates Cat.No 3 397 54

Insert whether the upper or lower part of your blanking plates in the modular window.



Clip the other part pushing towards the faceplate.



## DOCUMENT HOLDER

**OPEN WIDTH. 340X235 (CAT.NO 0 365 80)**

**OPEN WIDTH. 260X165 (CAT.NO 0 365 81)**

**CLOSED IP50 WIDTH. 324X120 (CAT.NO 0 365 82)**

**FLEXIBLE WIDTH. 305X220 (CAT.NO 0 097 99)**

Self-adhesive open document holders enable to keep inside your enclosure your electric plans, technical sheets, instructions among others. The latter are fixed inside the enclosure, on the door.

### ■ Mounting example - document holder :

Take off the plastic film from the double-sided adhesives positioned at the back of your holder. Then, stick it onto the door.

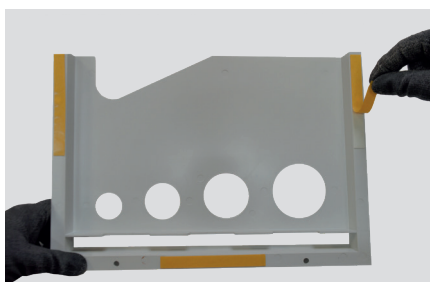

Cat.No 0 365 80, 0 365 81 :



Cat.No 0 365 82 :



Cat.No 0 097 99 :



### ■ Label holder

More than label-holders on our products, you can have a 24 modules self-adhesive label holder to clip Cat.No 3 397 55 and 36 modules Cat.No 3 397 56. Those products are delivered with a label sheet of labels.





# ENCLOSURES

## SHIPPING AND HANDLING

Enclosures' handling can be carried out using a lifting truck or lifting rings M12 (Cat.No 0 205 82). Before any operation, for enclosures standing next to each other, you must secure the process using a twinning kit Cat.No 3 379 49 (see page 10).



### ■ Handling via a lifting truck (width < 2 m)

Then you will be able to take off your bases sides to enable the insertion of the lift truck forks. This type of handling requires an extreme caution regarding the enclosure not to fall. Suitable precautions should be taken. Depending on the enclosure's width, it is possible to enter the forks to the front or at 45° regarding the forefront of the enclosure.

### ■ Handling via a lifting truck (width > 2 m)

When units of width of more than 2 m or when units contain heavy elements, handling operations can be done using angle crosspieces. It is recommended to ensure cables and lifting machines are appropriate. Ensure the angle formed by cables is below 90°.

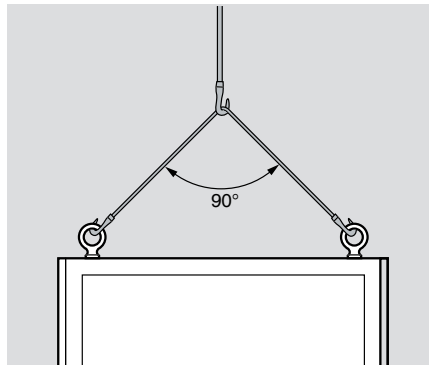

### ■ Handling via lifting (width > 2 m)

When units of width of more than 2 m or when units contain heavy elements, handling operations can be done using angle crosspieces. It is recommended to ensure cables and lifting machines are appropriate. Ensure the angle formed by cables is below 90°.

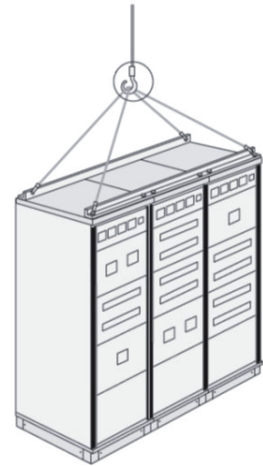







Protect the enclosure once mounted by using the original reusable packaging.



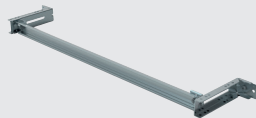
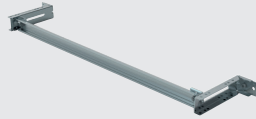
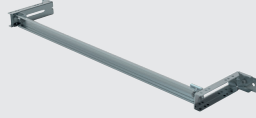

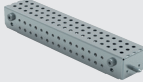

Enclosures can also be shipped in a vertical position, back-to-back, on a pallet, considering all the precautions needed (dunnage and strapping).

# SPARE PARTS & ACCESSORIES

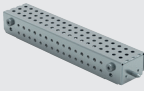
CAT.NO	DESIGNATION	CONTENT
3 379 49	XL <sup>3</sup> S 630/4000 Twin plates	 <p>1 link plate, 3 flat plates 16 self-tapping screws</p>
3 379 50	XL <sup>3</sup> S 630/4000 Twinning screws	 <p>8 screws, 2 nuts, 6 cage-nuts</p>
3 379 51	IP43 Kit	 <p>1 roll (10 m)</p>
3 382 20	DIN Rail 3 pos.16 M for XL <sup>3</sup> S	 <p>1 rail, 2 brackets, 2 fixing brackets and 4 self-tapping screws</p>
3 382 23	DIN Rail 3 pos.24 M for XL <sup>3</sup> S	 <p>1 rail, 2 brackets, 2 fixing brackets and 4 self-tapping screws</p>
3 382 26	DIN Rail 3 pos.36 M for XL <sup>3</sup> S	 <p>1 rail, 2 brackets, 2 fixing brackets and 4 self-tapping screws</p>
3 382 40	DPX <sup>3</sup> rail height spacer + modular	 <p>x 1</p>
3 382 41	DRX rail height spacer + modular	 <p>x 1</p>
3 382 42	DPX <sup>3</sup> rail height spacer + DRX	 <p>x 1</p>

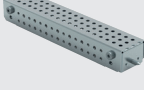

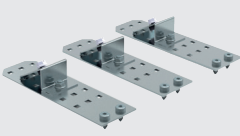

# SPARE PARTS & ACCESSORIES





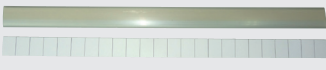
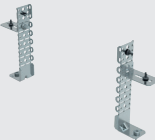



CAT.NO	DESIGNATION	CONTENT	
3 382 43	Universal rail 16 M		1 rail, 2 brackets, 2 FB, 2 self-tapping. screws, 4 nuts 4 metric screws
3 382 44	Universal rail 24 M		1 rail, 2 brackets, 2 FB, 2 self-tapping. screws, 4 nuts 4 metric screws
3 382 45	Universal rail 36 M		1 rail, 2 brackets, 2 FB, 2 self-tapping. screws, 4 nuts 4 metric screws
3 397 01	100 1/4 turns screws		100 screws and 100 cage-nuts
3 397 02	100 screws faceplate		100 screws, 100 clips, 100 washers, 25 claws
3 397 13	Replacement handle for XL <sup>3</sup> S 4000		1 handle, 2 circlips
3 397 18	Handle for XL <sup>3</sup> S 4000		1 handle, 2 circlips, 2 keys
3 397 21	Earth busbar support		2 supports, 2 clips, 4 crosshead screws 2 metric screws
3 397 30	Crosspieces for external cable sleeve		2 crosspieces 4 fixing brackets 8 self-tapping screws

CAT.NO	DESIGNATION	CONTENT	
3 397 31	Crosspieces for 16 M		2 crosspieces 4 fixing brackets 8 self-tapping screws
3 397 34	Crosspieces D. 400mm		2 crosspieces 4 fixing brackets 8 self-tapping screws
3 397 35	Crosspieces D.600mm (24 modules)		2 crosspieces 4 fixing brackets 8 self-tapping screws
3 397 36	Crosspieces D.800mm (36 modules)		2 crosspieces 4 fixing brackets 8 self-tapping screws
3 397 51	Universal inclined support vertical cable sleeve		3 perforated plates, 3 inclined plates, 3 dome head screws, 3 pipe-nuts, 3 metric screws, 6 self-tapping screws, 3 metric nuts
3 397 53	Equipotential bonding conductor		1 green/yellow cable, 1 self-tapping screw, 4 flat washers, 2 toothed nuts 1 metric screw
3 397 54	Blanking plate 24 M		x 1







# SPARE PARTS & ACCESSORIES

CAT.NO	DESIGNATION	CONTENT	
<b>3 397 55</b>	Self-adhesive label holder 24 M		1 label holder 1 sheet of labels
<b>3 397 56</b>	Self-adhesive label holder 36 M		1 label holder 1 sheet of labels
<b>3 397 58</b>	Duct fixing brackets		2 brackets 2 self-tapping screws 3 dome head or metric screws 2 metric nuts 4 plastic rivets
<b>0 205 82</b>	Lifting rings M12		x 4
<b>0 365 80</b>	Self-adhesive open doc. holder - width. 340 x H. 235 grey RAL 7035		x 1
<b>0 365 81</b>	Self-adhesive open doc. holder - width. 260 x H. 165 grey RAL 7035		x 1
<b>0 365 82</b>	Self-adhesive close doc. holder - IP 50 - 324x120x18 mm grey RAL 7035		x 1
<b>0 097 99</b>	Flexible plastic cover - 305 x 220 mm - transparent		x 1

CAT.NO	DESIGNATION	CONTENT	
0 016 60	Blanking plates 5 modules White RAL 9010		1 blanking plate 5 modules
0 373 01	Brassbar 24 M		1 brass bar 24 M, 2 FB , 2 cage-nuts, 2 screws 2 lock washers, 2 spacers 2 marking stickers
3 397 57	Brassbar 36 M		1 brass bar 36 M, 2 FB , 2 cage-nuts, 2 screws 2 lock washers, 2 spacers 2 marking stickers
3 399 41	Kit caps M8		x 50
3 399 42	Kit caps M10		x 50
3 399 43	Kit caps M12		x 50
0 477 12	Clip nut M6		x50
9 809 00	Screw auto XL <sup>3</sup> S		x 50

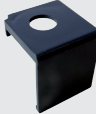
# SPARE PARTS & ACCESSORIES

CAT.NO	DESIGNATION	CONTENT	
9 809 04	XL <sup>3</sup> S 630/4000 door hinge		1 hinge, 1 axle, 1 screw M6 1 cage-nut
9 809 13	LINK.SYST.DOOR H2000 mm		2 links, 2 supports
9 809 14	LINK.SYST.DOOR H2200 mm		2 links, 2 supports
9 809 16	LOCK.SYST.LINK.4000		1 locking system link H75mm, 2 rings 1 closure screw
9 809 17	XL <sup>3</sup> S 630 Door's locking hook		1 locking hook, 1 M6 screw 1 cage-nut
9 809 18	Angle cover XL <sup>3</sup> S 4000		x 1
9 809 20	Cage nut		x50

To know more,  
check [export.legrand.com](http://export.legrand.com)



All technical data of the products inside this workshop specifications book are available on : [www.legrand.com/ecatalogue/](http://www.legrand.com/ecatalogue/)

>Click on>LIBRARY OF DOCUMENTS

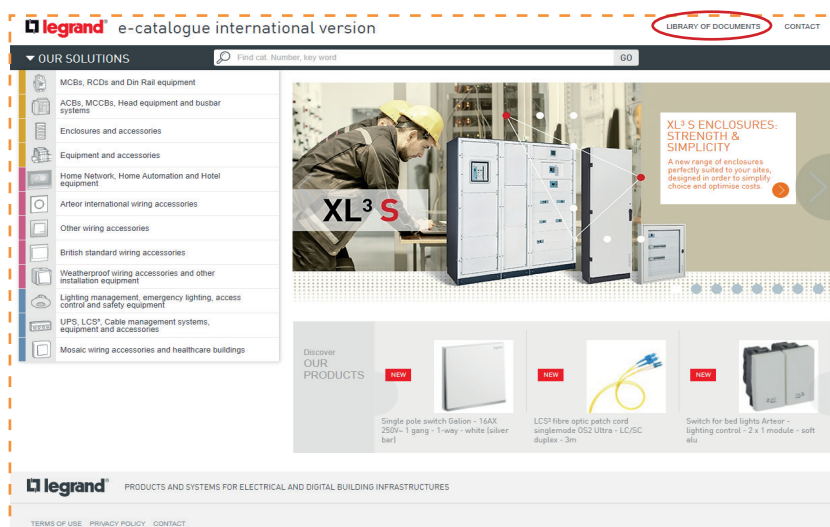



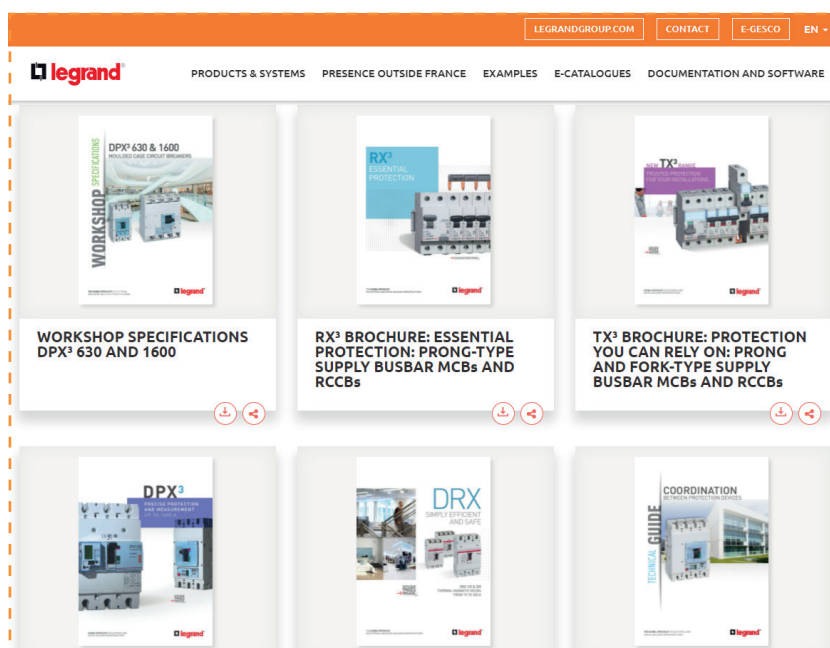

>Documentation





## FOLLOW US ALSO ON

- @ legrand.com
-  youtube.com/user/legrand
-  facebook.com/Legrand
-  twitter.com/Legrand
-  pinterest.com/legrandgroup
-  instagram.com/legrandnews



**Head office**  
and International Department  
87045 Limoges Cedex - France  
Tel: + 33 (0) 5 55 06 87 87  
Fax: + 33 (0) 5 55 06 74 55